

AUDIO RECEIVER

AR-404/KRF-A4030/ A4030E/A4030-S

SERVICE MANUAL

KENWOOD

AR-404/KRF-A4030/A4030E/A4030-S

CONTENTS / ACCESSORIES / CAUTIONS

© 2000-1/B51-5595-00 (K/K) 3174

Contents	
CONTENTS / ACCESSORIES / CAUTIONS	2
CIRCUIT DESCRIPTION	3
ADJUSTMENT	6
PC BOARD	7
SCHEMATIC DIAGRAM	11
EXPLODED VIEW	20
PARTS LIST	21
SPECIFICATIONS	27

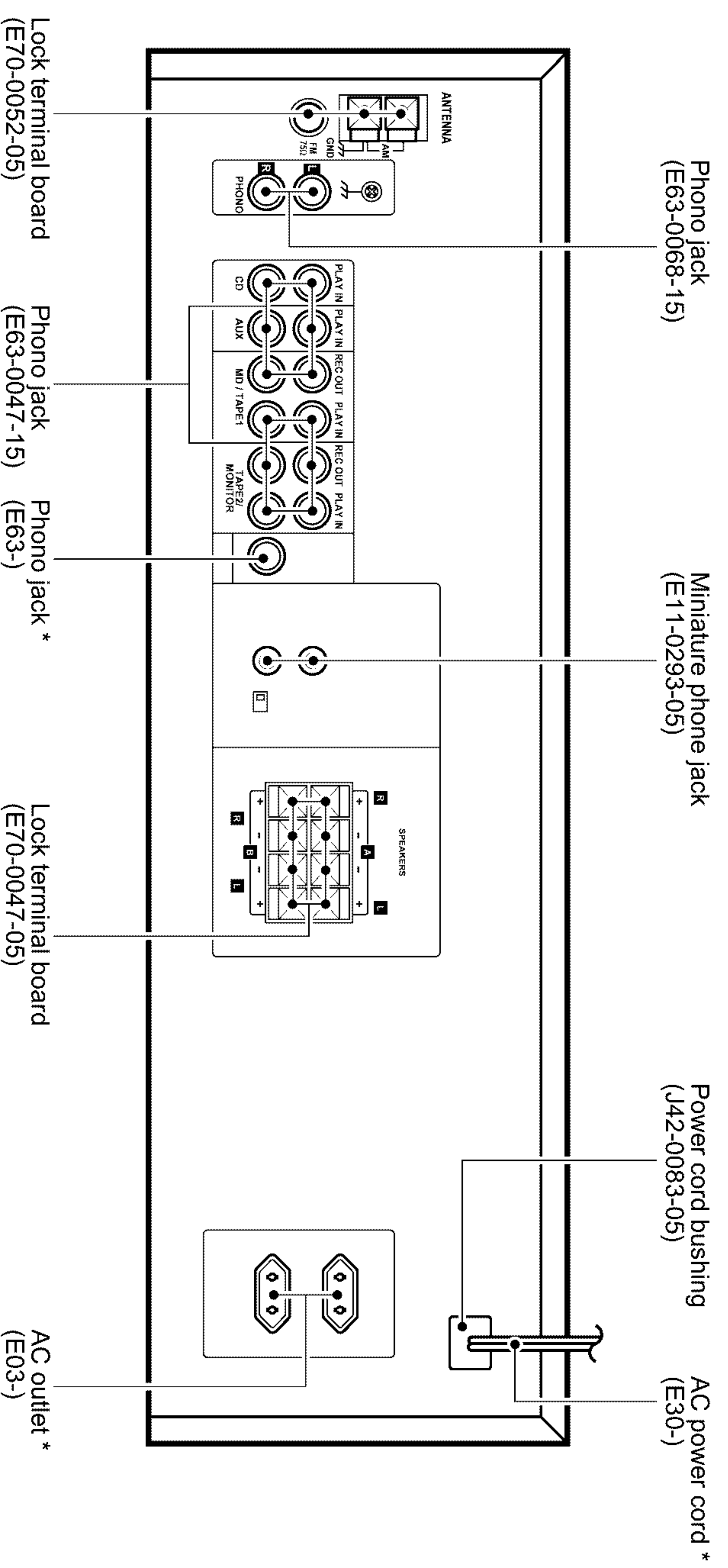
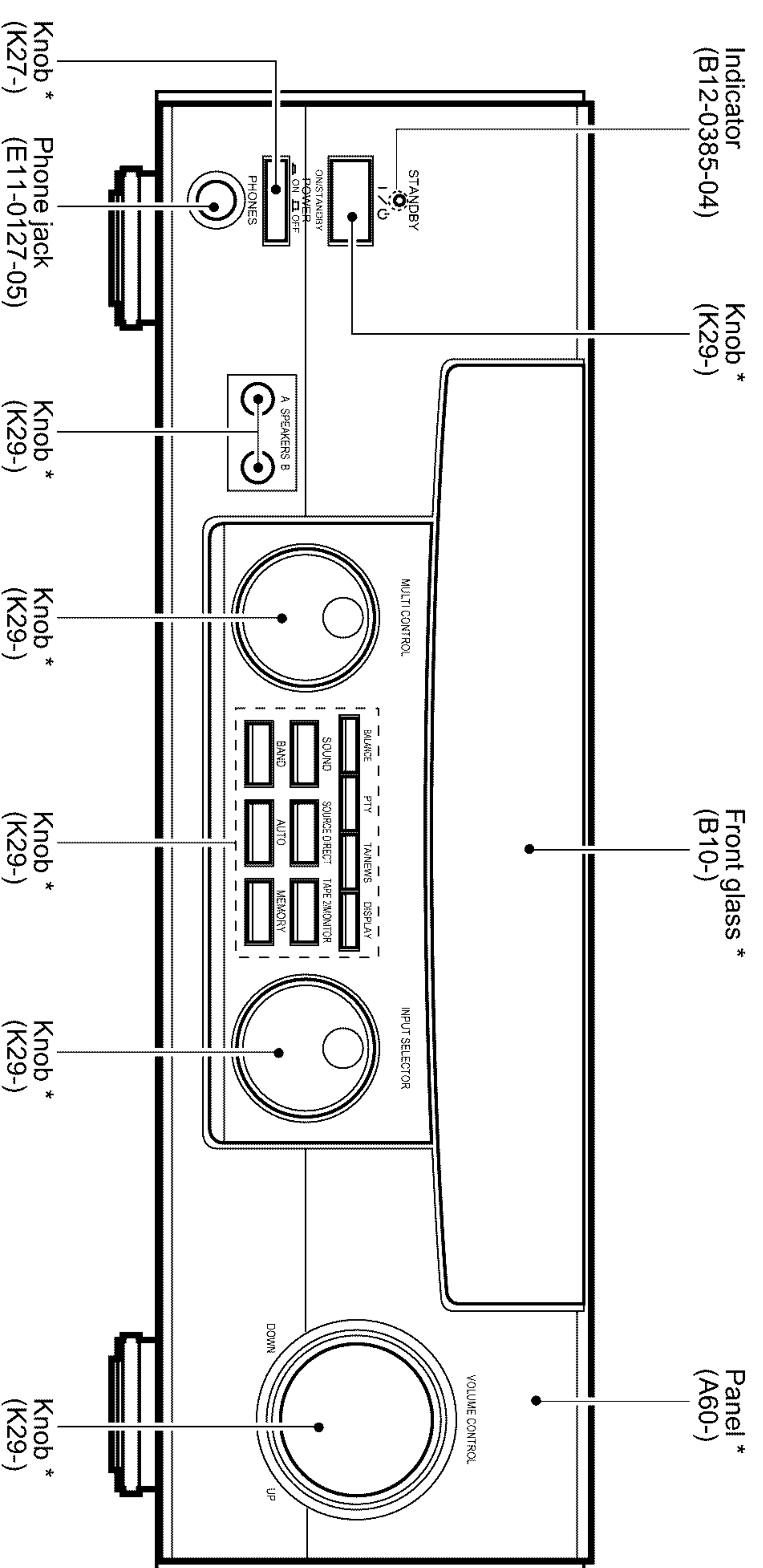

Accessories

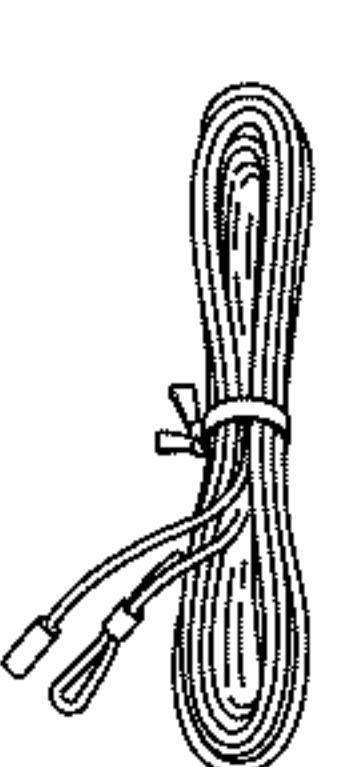
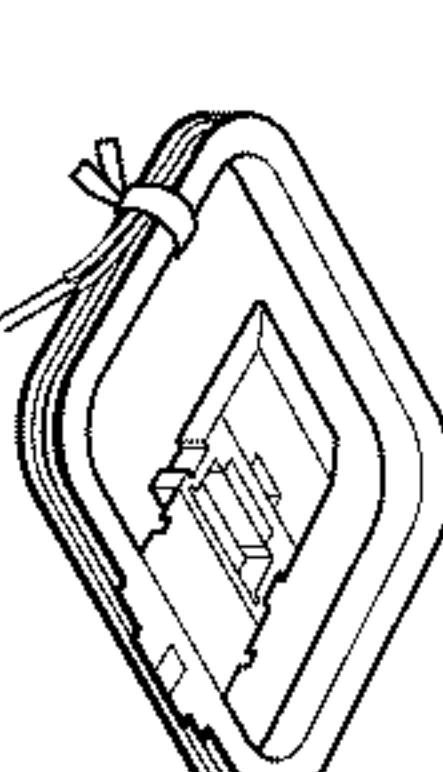
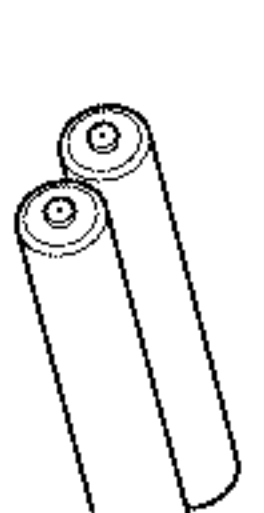
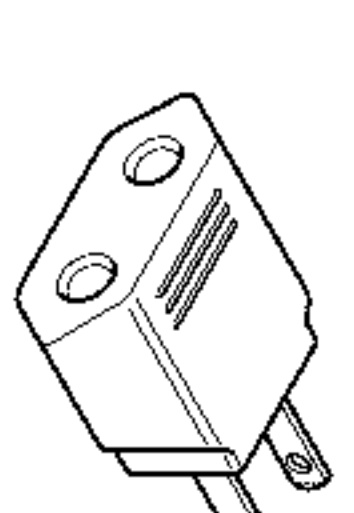
 FM indoor antenna (1) (T90-0836-05)	 AM loop antenna (1) (T90-0852-05)	 Batteries (R06/AA) (2)	 AC plug adaptor (1) (E03-0115-05)
<p>Remote control unit (1) (A70-1266-05): RC-R0709.....KPMX (A70-1267-05): RC-R0708.....E1E2E3</p>			
<p>*Use to adapt the plug on the power cord to the shape of the wall outlet. (Accessory only for regions where use is necessary.)</p>			

Cautions

Resetting the Microcomputer

If the microcomputer may malfunction (unit cannot be operated, or shows an erroneous display) if the power cord is unplugged while the power is ON, or due to some other external factor. If this happens, execute the following procedure to reset the microcomputer and return the unit to its normal operating condition.

For U.S.A. and Canada

Unplug the power cord from the wall outlet, then plug it back in while holding down the POWER key.

Except for U.S.A. and Canada

With the power cord plugged in, turn the POWER key OFF. Then, while holding down the ON/STANDBY key, press the POWER key.

- Please note that resetting the microcomputer will clear the contents of the memory and returns the unit to the state it was in when it left the factory.



CIRCUIT DESCRIPTION

CIRCUIT DESCRIPTION

1. BACK UP DATA AND INITIAL STATE

1-1 BACK UP

- (1) AMP
- POWER.....STANDBY
- INPUT SELECTOR.....TUNER
- BALANCE.....CENTER
- SPEAKER A RELAY.....ON
- SPEAKER B RELAY.....OFF
- VOLUME LEVEL.....-66dB
- BASS LEVEL.....0dB
- TREBLE LEVEL.....0dB
- INPUT LEVEL.....0dB
- SOURCE DIRECT.....OFF
- TAPE2/MONITOR.....OFF

(2) TUNER

- BAND.....FM
- PRESET CHANNEL.....FM
- FREQUENCY.....LOWER LIMIT VALUE
- K1.....FM:87.50MHz
- E1/E3.....AM:530kHz
- AM:87.50MHz
- AM:531kHz
- AUTOMANUAL.....AUTO
- DISPLAY MODE.....FREQUENCY
- E ON THRUST RECEIVING.....OFF
- MODE
- T1 VOLUME.....OFF(-66dB)

1-2 INITIAL SETTING

The initial setting is performed when the AC power cord is plugged into the AC power wall outlet while pressing the power (STANDBY) key.

2. DESTINATION LIST OF TUNER

DESTINATION	TUNER TYPE	BAND	RECEIVING FREQUENCY RANGE	CHANNEL SPACE	IF	PLL REFERENCE FREQUENCY	DSW3 (D507)	DSW2 (D505)	DSW1 (D504)	DSW0 (D510)
K,P	K1(1700)	FM AM	87.5MHz~108.0MHz 530kHz~1700kHz	100kHz 10kHz	+10.7MHz +450kHz	25kHz 10kHz	0	0	0	0
M,X	E1	FM AM	87.5MHz~108.0MHz 531kHz~1602kHz	50kHz 9kHz	+10.7MHz +450kHz	25kHz 9kHz	0	0	1	1
M	K2(1600)	FM AM	87.5MHz~108.0MHz 530kHz~1610kHz	100kHz 10kHz	+10.7MHz +450kHz	25kHz 10kHz	0	0	0	1
E	E3	FM AM	87.5MHz~108.0MHz 531kHz~1602kHz	50kHz 9kHz	+10.7MHz +450kHz	25kHz 9kHz	0	1	0	1

DSW0-DSW3(DIODE SW) * 0: NONE DIODE,1:ADD DIODE

3. TEST MODE

3-1 SETTING

Turn the power ON while pressing the [BAND] key.

3-2 CANCELLATION

Unplug the AC power cord from an AC power wall outlet.

3-3 STARTING ACTIVE CONTENTS

- The power on state is entered whenever the power is turned on while pressing the [BAND] key.
- All functions are initialized and activated in the all lighting mode.
- All lighting mode is canceled when any main unit's keys are pressed. The normal display obtained when the selector is set to TUNER then appears.
- E2PROM check(Etype only).

Check the reading data and the writing data of the E2PROM after setting the test mode.

Display shows blank if the reading data and writing data are the same. Display shows "LW" if the different data will be written to E2PROM.

3-4 ACTIVE CONTENTS

- The mute control is not activated when the mode is switched.
- The test mode will be terminated by plugging it off the power source or by initializing it when all the settings will be initialized.

4. Microprocessor CXP82840-163Q, CXP82832-162Q (X09, IC51)

4-1 Microprocessor periphery block diagram diagram

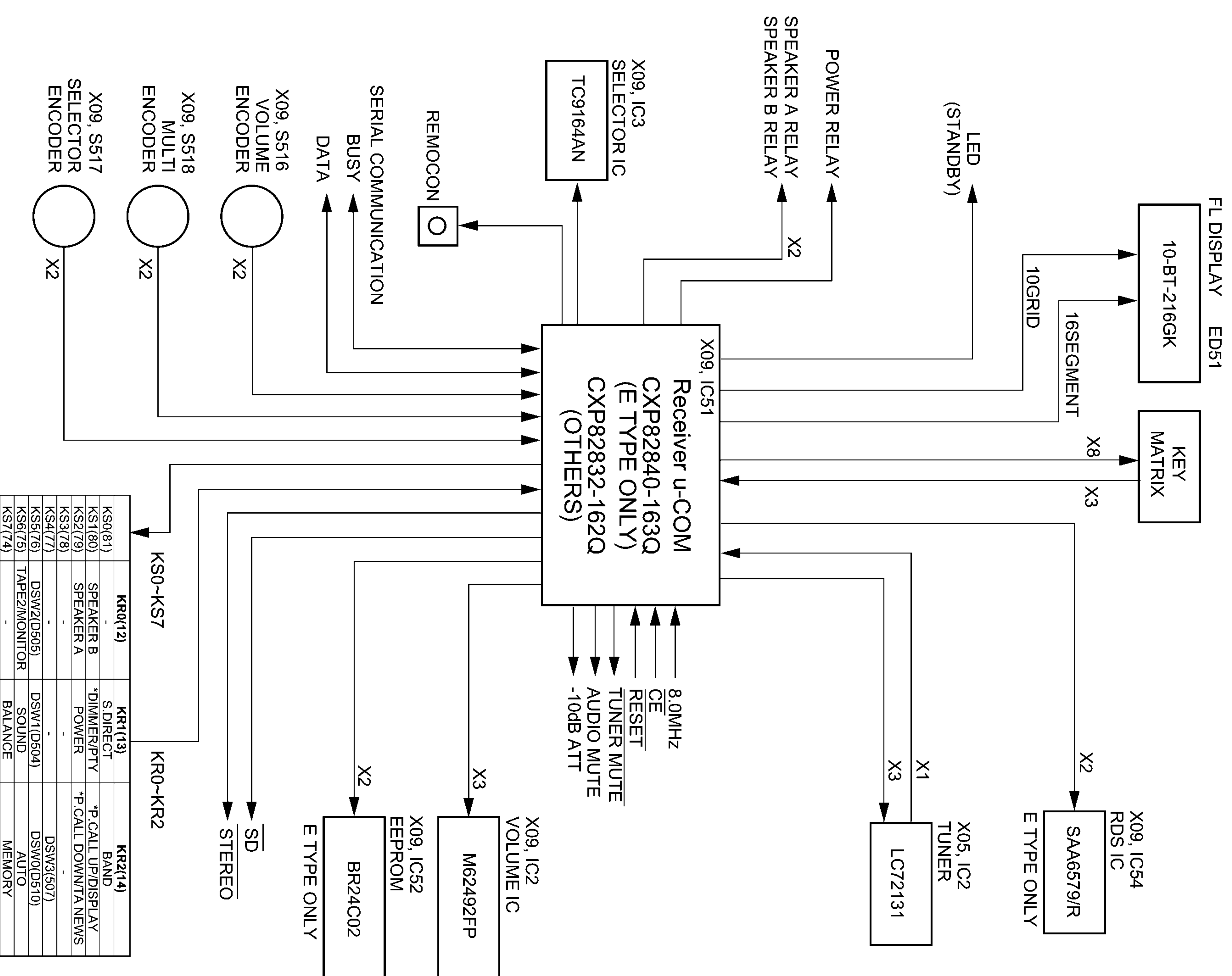

3-5 CONTENTS

3-5-1 TUNER FUNCTION WITH THE SELECTOR ON TUNER (E TYPE ONLY)

OPERATION KEY	FUNCTION	FL DISPLAY	REMARKS
PTY	S LEVEL (1)(SLEVEL), RF ATT (2)(SLEVEL), (RF ATT) (3)(NORMAL), (RFATT) OFF	(EX) (1) (SLEVEL), (2) (SLEVEL), (3) (NORMAL), (RFATT) OFF	(1) (2) (3) CYCLE
DISPLAY TANEWS	P CALL UP P CODE PI 0000	P CALL FREQUENCY PI 0000	PI CODE ON/OFF

3-5-2 AMP FUNCTION WITH THE SELECTOR ON SOMETHING OTHER THAN TUNER

- One touch max,min setting for Audio level.

KEY	SOUND KEY		
	MASTER VR.	BASS	TREBLE
BAND	-89dB	0dB	+10dB
AUTO	0dB	0dB	+10dB
MEMORY	-10dB	0dB	+10dB

Bass and treble are selected while the sound key is pressed.

PTTY, DISPLAY and TANEWS keys are only RDS version(E type).	KR0(12)	KR1(13)	KR2(14)
KS0(81)	-	S DIRECT	BAND
KS1(80)	-	*DIMMER/PTY	*P CALL UP/DISPLAY
KS2(79)	SPEAKER B	POWER	*P CALL DOWN/TANEWS
KS3(78)	SPEAKER A	-	-
KS4(77)	-	-	DSW3(D507)
KS5(76)	-	-	DSW1(D504)
KS6(75)	TAPE2/MONITOR	SOUND	DSW0(D510)
KS7(74)	-	BALANCE	AUTO MEMORY

4.2 Microprocessor pin descriptions: X09,IC51

Pin No.	Pin name	I/O	Description	Active
1,2	G9,G10	O	FL grid control (9,10).	
3	NC	-	u-Com +5V power supply.	
4	RDS,CK	I	RDS IC clock input control. (E type only)	
5	RDS,DT	I	RDS IC data input control. (E type only)	
6	NC	I	u-Com +5V power supply.	
7	VOL.ENC.A	I	Volume encoder A (CW) signal.	
8	REMOCON	I	Remote control signal input.	
9	VOL.ENC.B	I	Volume encoder B (CCW) signal.	
10,11	NC	-	Unused.	
12~14	KR0~KR2	I	Key return (0~2).	
15	PROTECT	I	Protection detection signal input.	H: Protection ON
16	S.DATA	I/O	Serial communication data.	
17	S.BUSY	I/O	Serial communication busy.	
18	E2.DATA	I/O	E2 PROM data.	
19	E2.CLK	O	E2 PROM clock.	
20	SEL.ENC2 CW	I	Selector encoder A(CW) input.	
21	SEL.ENC2 CCW2	I	Selector encoder B(CCW) input.	
22	MLT. ENC3 CW3	I	Multi control encoder A(CW).	
23	MLT. ENC3 CCW3	I	Multi control encoder B(CCW).	
24	8/16	I	Serial communication 8bit/16bit changeover.	
25~27	NC	-	Unused.	
28	AV REF	-	Analog reference voltage (+5V).	
29	S.LEVEL	I	Signal level A/D input. (E type only)	
30~32	NC	-	Unused.	
33	PLL.DO	I	PLL IC DO signal input. (E type only)	L: STEREO
34	PLL.STEREO	I	TUNER stereo signal input.	L: TUNED
35	PLL.SD	I	TUNER SD signal input.	L: ENABLE
36	RCV.CE	I	Receiver chip enable signal input.	
37	AVSS	-	Analog ground.	
38	RESET	I	u-Com reset.	
39	EXTAL	I	Main clock(8MHz).	
40	XTAL	-	Main clock(8MHz).	
41	VSS	-	u-Com ground.	
42	TX	I	Unused.	
43	TEX	I	Ground.	
44	VDD	-	Analog power supply (+5V).	
45	VFD P	-	FL power supply(-33V).	
46	SEL.STB	O	TC9164AF strobe.	H: LATCH
47	SEL/PLL.DT	O	Selector/PLL IC data signal output.	
48	SEL/PLL.CK	O	Selector/PLL IC clock signal output.	
49	PLL.CE	O	PLL IC CE signal output.	
50	T.MUTE	O	Tuner mute control.	L: MUTE ON
51	A.MUTE	O	Audio mute control.	L: MUTE ON
52	NC	-	Unused.	
53	10dB.ATT	O	Volume 10dB attenuator control.	L: ATT ON
54	VOL.DT	O	Volume IC(M62492FP) data control.	
55	VOL.CK	O	Volume IC(M62492FP) clock control.	
56	VOL.STB	O	Volume IC(M62492FP) strobe control.	
57~59	NC	-	Unused.	
60	RELAY.A	O	SP. relay A control.	H: RELAY ON
61	RELAY.B	O	SP. relay B control.	H: RELAY ON
62,63	NC	-	Unused.	
64	POWER.RLY	O	Power relay control.	H: RELAY ON
65	STANDBY.LED	O	STANDBY LED control.	H: LED ON
66~71	NC	-	Unused.	
72	LIMITER	O	Output power control at SP. (A+B). K/M/X only.	
73	S.W.MUTE	-	Unused.	
74,75	KS6/KS7	O	Key scan 6,7.	
76~81	P1/KS5~P6/KS0	O	FL segment 1~6/key scan 5~0.	
82~88	P7~P13	O	FL segment 7~13.	
89	VDD	O	u-Com +5V power supply.	
90~92	P14~P16	O	FL segment 14~16.	
93~100	G1~G8	O	FL GRID 1~8.	

No.	ITEM	INPUT SETTINGS	OUTPUT SETTINGS	RECEIVER SETTINGS	ALIGNMENT POINTS	ALIGN FOR	FIG.
FM SECTION : EXCEPT E type SELECTOR : FM							
1	DISTORTION (STEREO)	(C) 98.0MHz 1kHz, ±68.25kHz dev. Selector : L or R Pilot : ±6.75kHz dev. 70dBf (ANT. input)	(B)	98.0MHz	IFT (TUNER UNIT: A1)	Minimum distortion (L or R)	(a)
2	TUNING LEVEL	(A) 98.0MHz MONO 1kHz, ±75kHz dev. 25dBf (ANT. input)	(B)	MONO 98.0MHz	VR1 (TUNER UNIT)	Adjust VR1 and stop at the point where ED51 (TUNED) goes on.	(a)
FM SECTION : E type only SELECTOR : FM * Adjust NO.1 and NO.2 repeat.							
1	DISCRIMINATOR	(A) 98.0MHz 1kHz, ±40kHz dev. 70dBf (ANT. input)	Connect a DC voltmeter between CN2 ① and CN2 ② (TUNER UNIT)	MONO 98.0MHz	L4 (TUNER UNIT)	0V	(a)
2	DISTORTION (MONO)	(A) 98.0MHz 1kHz, ±40kHz dev. MONO 70dBf (ANT. input)	(B)	MONO 98.0MHz	L5 (TUNER UNIT)	Minimum distortion	(a)
3	DISTORTION (STEREO)	(C) 98.0MHz 1kHz, ±40kHz dev. Selector : L or R Pilot : ±6kHz dev. 70dBf (ANT. input)	(B)	AUTO 98.0MHz	IFT (TUNER UNIT : A1)	Minimum distortion (L or R)	(a)
4	TUNING LEVEL	(A) 98.0MHz MONO 1kHz, ±40kHz dev. 25dBf (ANT. input)	(B)	MONO 98.0MHz	VR1 (TUNER UNIT)	Adjust VR1 and stop at the point where ED51 (TUNED) goes on.	(a)
AUDIO SECTION							
1	IDLE CURRENT	-	Connect a DC Voltmeter across CN11 (L) CN12 (R)	Volume: 0	VR1 (L) VR2 (R)	11 mV	(b)

SYSTEM CONNECTIONS

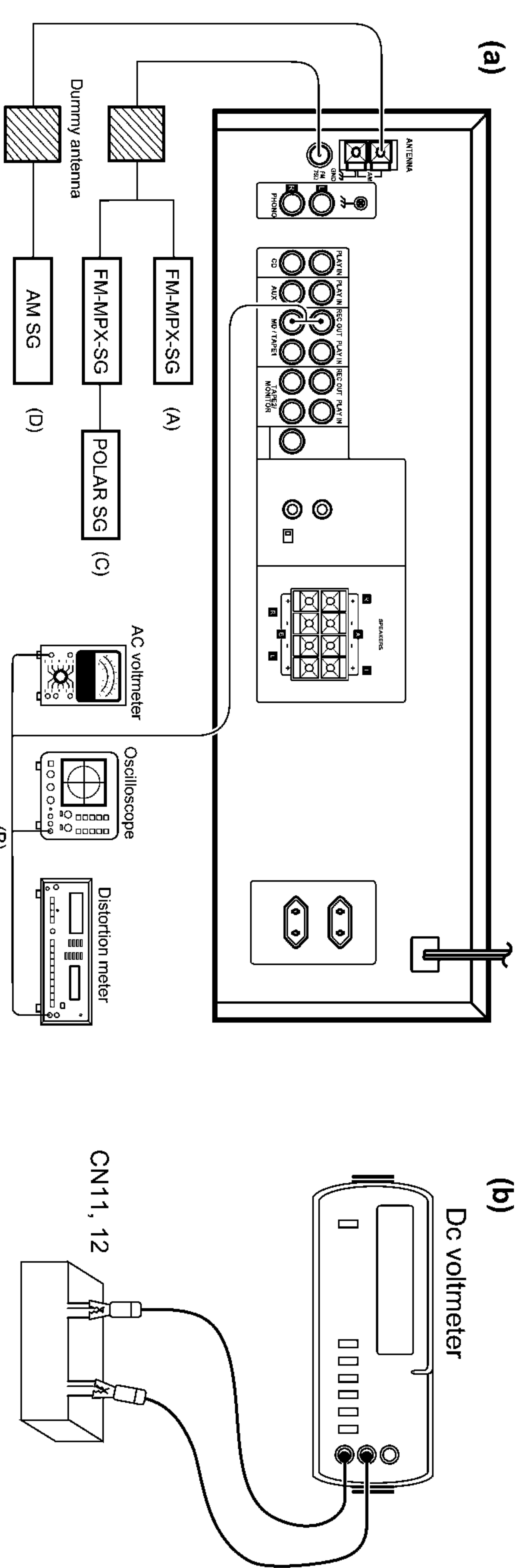

PC BOARD (Component side view)

TUNER UNIT X05-498X-XX

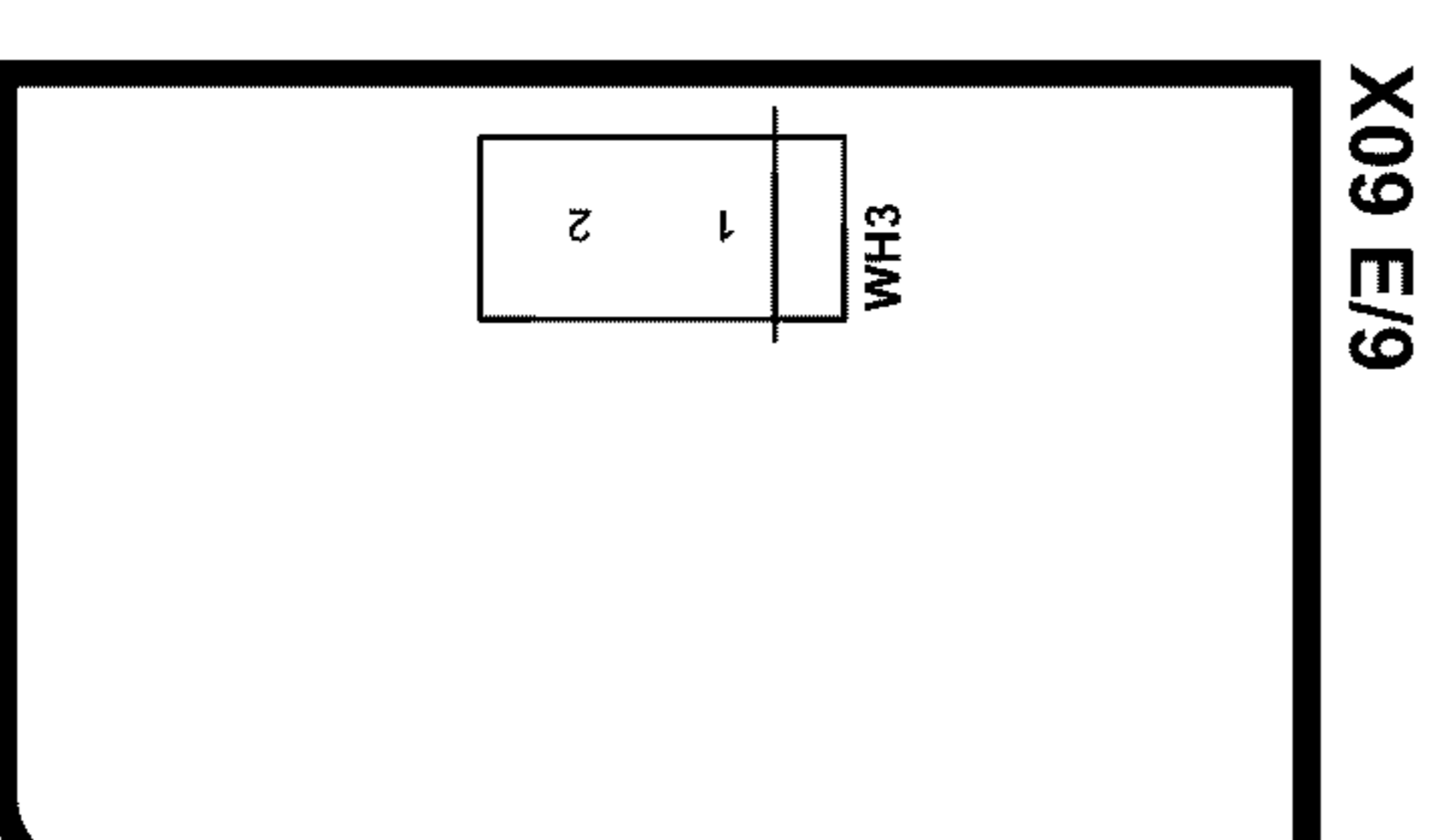
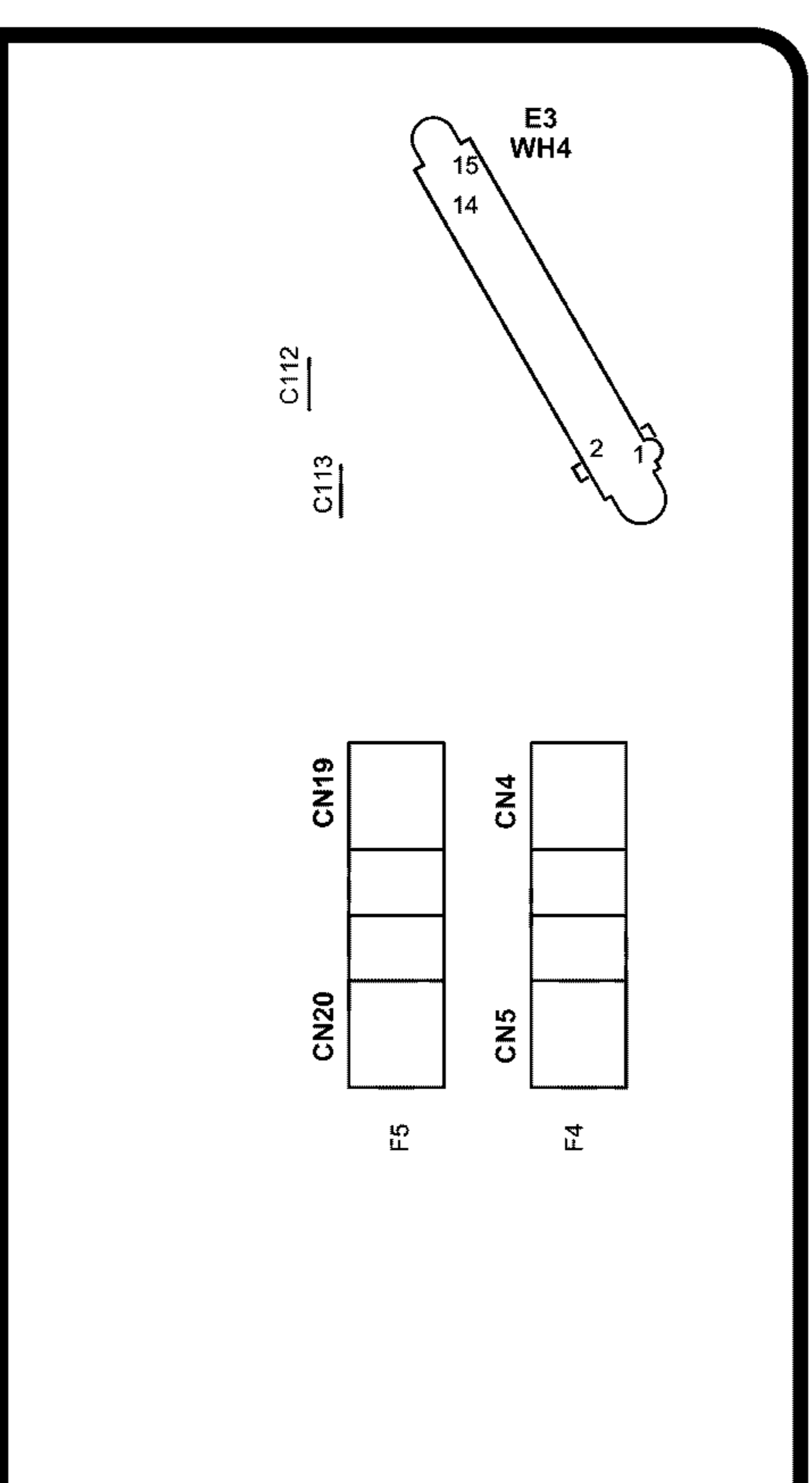
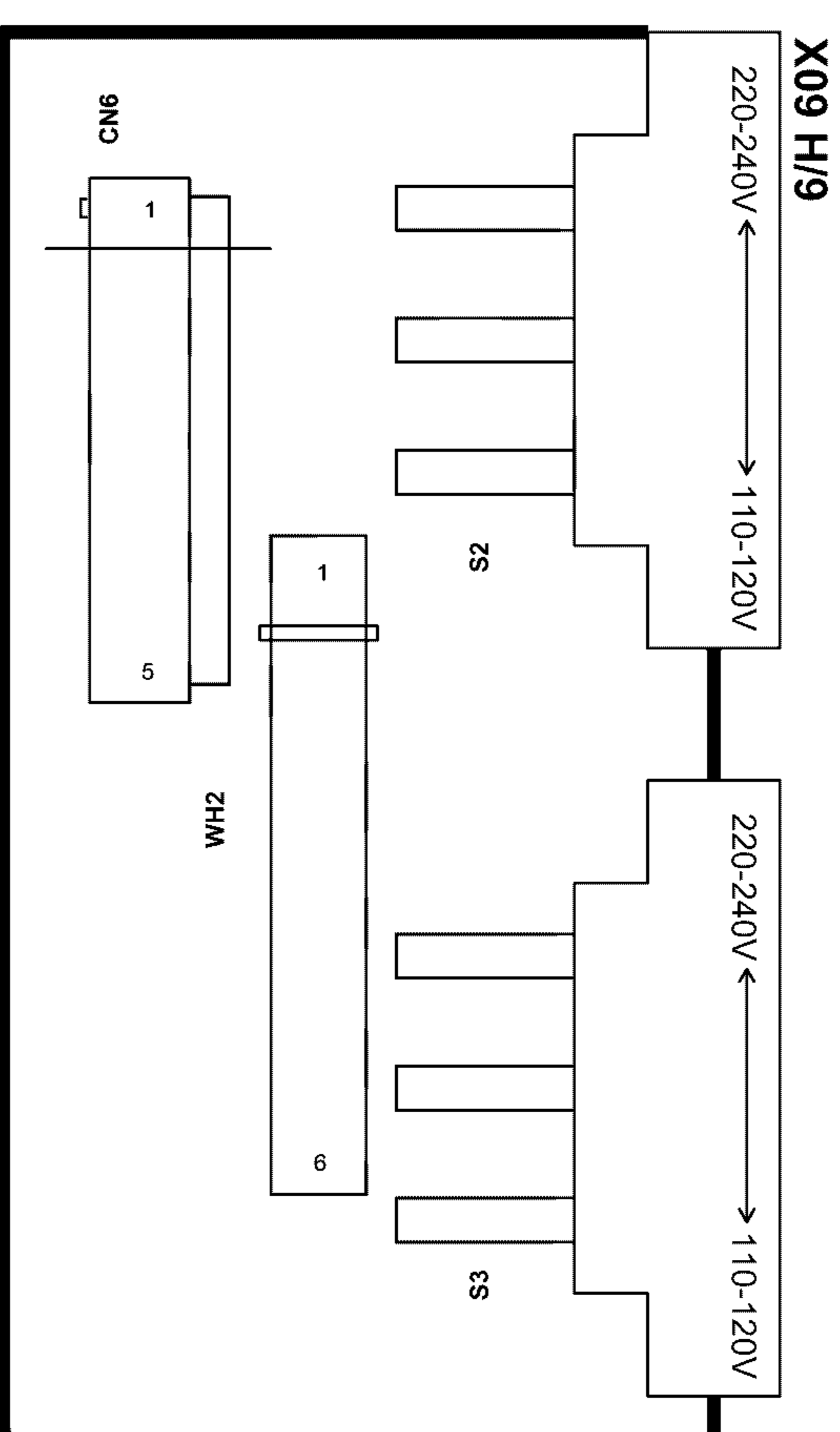
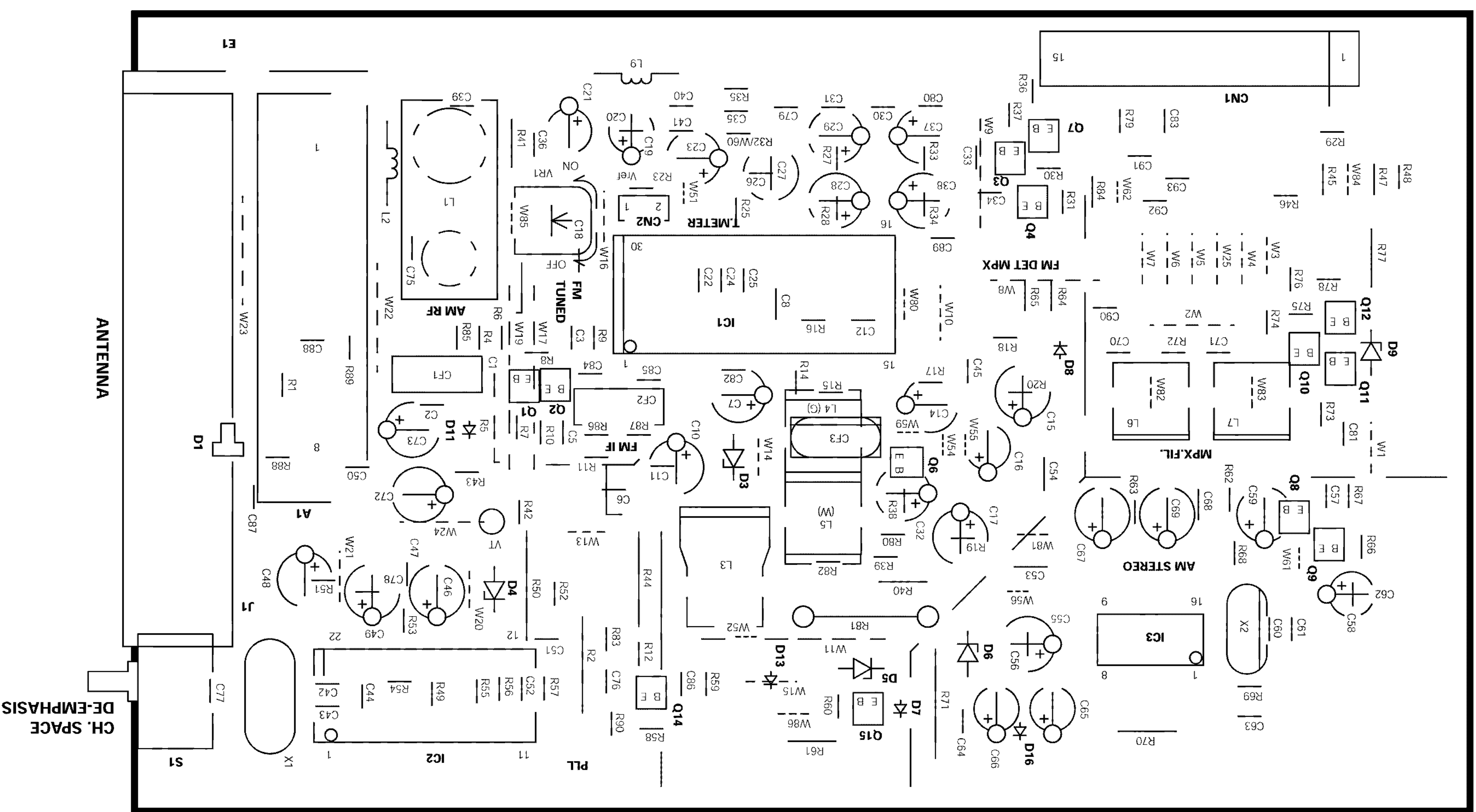

PC BOARD (Component side view) AUDIO UNIT



AC OUTLET

X09-6410-10 A/9 (J70-1366-11)

SPEAKERS

SYSTEM CONTROL

PRE OUT

TAPET/MONITOR
PLAY IN REC OUT

AUX
PLAY IN REC OUT

CD
PLAY IN

PHONO

X09 G/9

PHONES

X09 C/9

X09 B/9

X09 F/9

X09 I/9

VOLUME CONTROL

POWER SW

Refer to the schematic diagram for the value of resistors and capacitors.

9

10

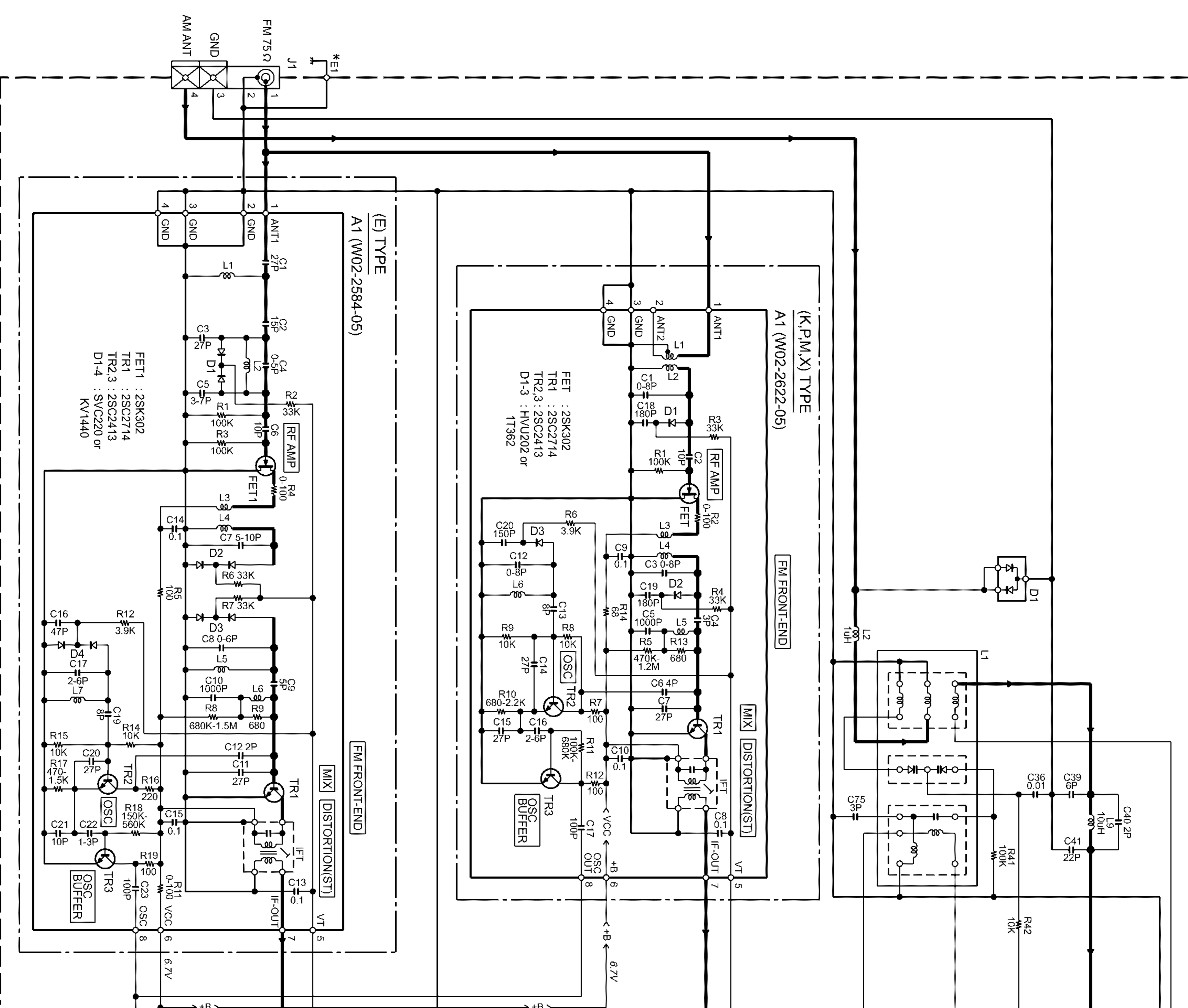

- IC1 : * : DA204U or MA143A or LC72131
 IC2 : * : 2SD1819(A,Q,R) or 2SC4081(R,S) or 2SC4116(Y,S8)
 Q1,3,4,6,7 : 2SB1218(A,Q,R) or 2SA1578(A,R,S) or 2SA1586(Y,G,F)
 Q2,12,14 : 2SB1218(A,Q,R) or 2SA1578(A,R,S) or 2SA1586(Y,G,F)
 Q10,11 : 2SD1757K
- D1 : DA204U or MA143A or 1SS302
 D3 : R02.2E5(B2) or MZ2.8.2(B) or HZ58.2N(B2) or R05.7E5(B2) or MZ2.8.1(B) or HZ55.1N(B2)
 D4 : R05.7E5(B2) or MZ2.8.1(B) or HZ55.1N(B2)
 D5 : R02.7E5(B2) or MZ2.2.7(B) or HZ52.7N(B2)
 D8,11,13 : MA111
 D9 : R03.3E5(B2) or MZ2.3.3(B) or HZ53.3N(B2)
- A1 : *

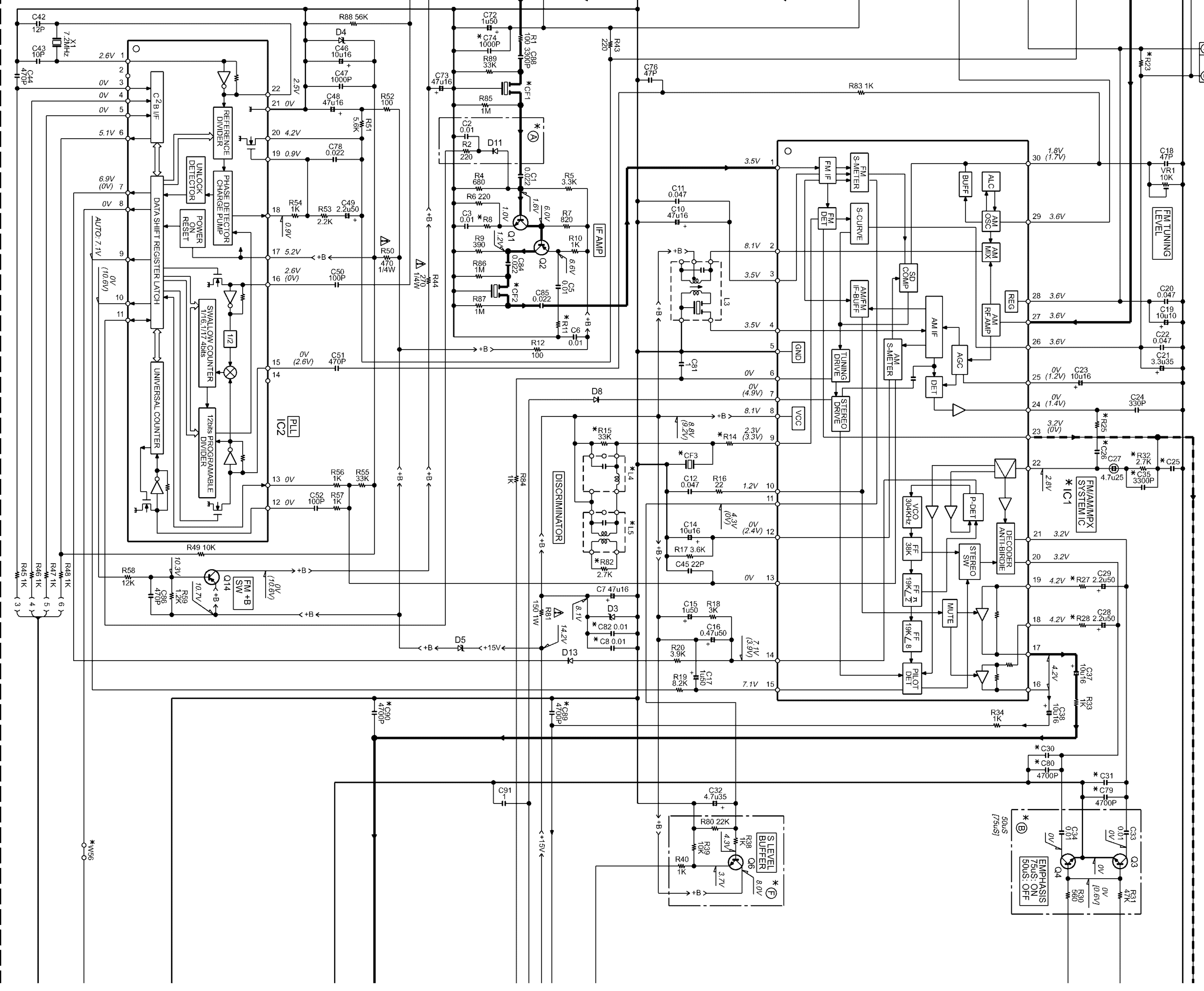
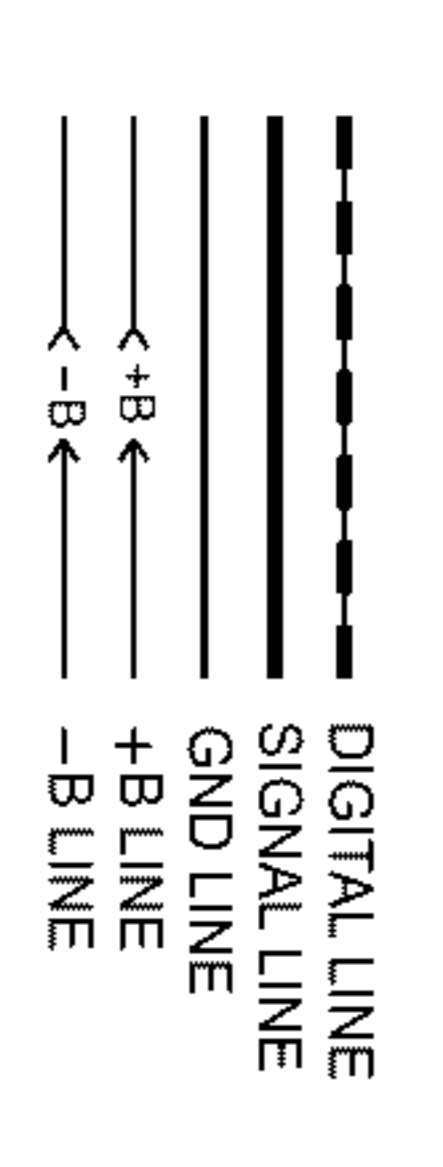

(X05-498X-XX)

AR-404 (X05-4980-11)

DESTINATION		UNIT No.	(A)	(B)	(C)	(F)	R8, 11	R14	R15, 32, 82	R23	R25	R27, 28	R29, 36	R72, 73	C8, 70, 71, 77, 79, 80	C25	C26	C30, 31	C35, 82, 74, 89, 90	
COUNTRY	ABB.		0-11	NO				33	100	YES	4.7K	22K	6.2K	NO	15K	NO	470P	0.022	0.033	YES
U.S.A.	K																			
CANADA	P																			

DESTINATION		UNIT No.	(A)	(C)	(F)	(B)	R8	R11	R14	R15, 36, 82	R23	R25	R27, 28	R29	R32	R72, 73	C8, 35, 74, 77, 89, 90	C25	C26	C30, 31	C70, 71, 79, 80, 82	C74	C77	
COUNTRY	ABB.		W02-2622	L72-0596 (MS2)	NO	LA1837	YES	NO	YES	NO	YES	NO	YES	NO	YES	NO	F10-1129							
U.S.A.	K																							
CANADA	P																							

KRF-A4030S (X05-4980-23)

DESTINATION		UNIT No.	(A)	(C)	(F)	(B)	R8	R11	R14	R15, 36, 82	R23	R25	R27, 28	R29	R32	R72, 73	C8, 35, 74, 77, 89, 90	C25	C26	C30, 31	C70, 71, 79, 80, 82	C74	C77	
COUNTRY	ABB.		0-23	YES				33	33	270	NO	3.3K	18K	7.5K	YES	YES	8.2K	YES	470P	0.022	0.022	NO	NO	YES
U.S.A.	K																							
CANADA	P																							

DESTINATION		UNIT No.	(A)	(C)	(F)	(B)	R8	R11	R14	R15, 36, 82	R23	R25	R27, 28	R29	R32	R72, 73	C8, 35, 74, 77, 89, 90	C25	C26	C30, 31	C70, 71, 79, 80, 82	C74	C77	
COUNTRY	ABB.		W02-2622	L72-0531 (MA5)	YES	LA1838	NO	NO	YES	YES	NO	NO	YES	YES	YES	YES	F10-1129							
U.S.A.	K																							
CANADA	P																							

KRF-A4030 (X05-4982-72)

DESTINATION		UNIT No.	(A)	(C)	(F)	(B)	R8	R11	R14	R15, 82	R23	R25	R27, 28	R29	R32	R36	R72, 73	C8, 35, 74, 77, 89, 90	C25	C26	C30, 31	C70, 71, 79, 80, 82	
COUNTRY	ABB.		2-72	YES	NO	10	22	100	YES	15K	27K	4.3K	NO	W60	YES	3.9K	NO	180P	0.018	0.022	YES		
U.S.A.	K																						
CANADA	P																						

DESTINATION		UNIT No.	(A)	(C)	(F)	(B)	R8	R11	R14	R15, 6, 7	R23	R25	R27, 28	R29	R32	R36	R72, 73	C8, 35, 74, 77, 89, 90	C25	C26	C30, 31	C70, 71, 79, 80, 82	
COUNTRY	ABB.		W02-2584	L72-0536 (MS3)	NO	LA1837	YES	YES	NO	NO	NO	NO	NO	NO	NO	F10-1128							
U.S.A.	K																						
CANADA	P																						

KRF-A4030E (X05-4982-72)

DESTINATION		UNIT No.	(A)	(C)	(F)	(B)	R8	R11	R14	R15, 82	R23	R25	R27, 28	R29	R32	R36	R72, 73	C8, 35, 74, 77, 89, 90	C25	C26	C30, 31	C70, 71, 79, 80, 82	
COUNTRY	ABB.		2-72	YES	NO	10	22	100	YES	15K	27K	4.3K	NO	W60	YES	3.9K	NO	180P	0.018	0.022	YES		
U.S.A.	K																						
CANADA	P																						

DESTINATION		UNIT No.	(A)	(C)	(F)	(B)	R8	R11	R14	R15, 6, 7	R23	R25	R27, 28	R29	R32	R36	R72, 73	C8, 35, 74, 77, 89, 90	C25	C26	C30, 31	C70, 71, 79, 80, 82	
COUNTRY	ABB.		W02-2584	L72-0536 (MS3)	NO	LA1837	YES	YES	NO	NO	NO	NO	NO	NO	NO	F10-1128							
U.S.A.	K																						
CANADA	P																						

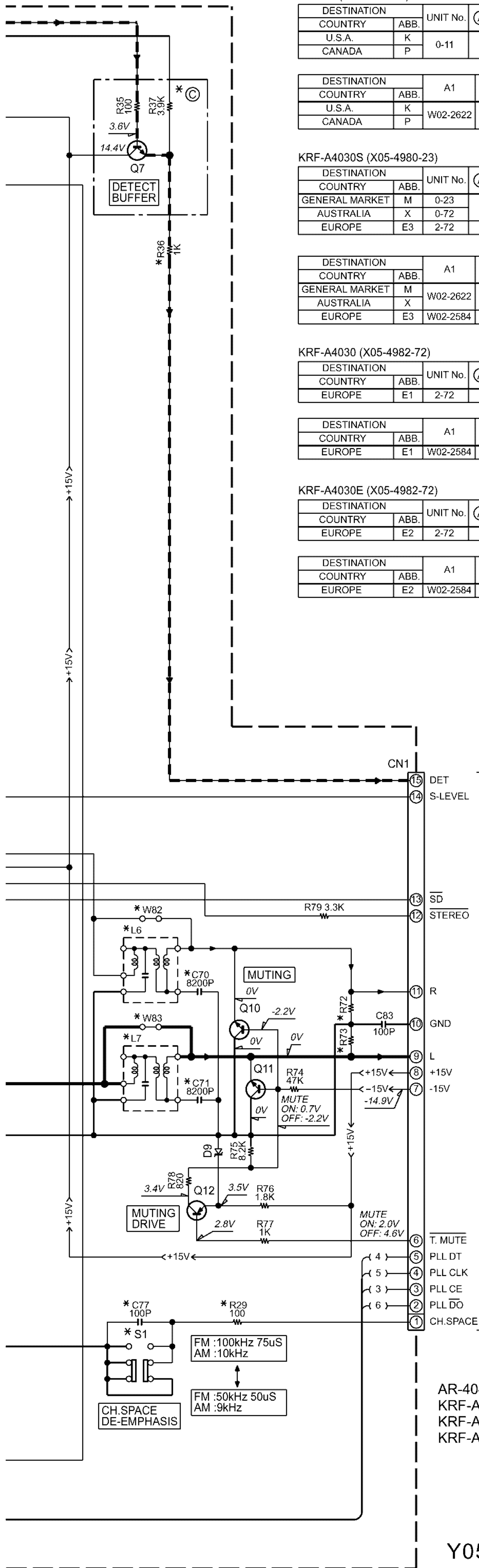

CAUTION: For continued safety, replace safety critical components only with manufacturer's recommended parts (refer to parts list). Δ indicates safety critical components. For continued protection against risk of fire, replace only with same type and rating fuse(s). To reduce the risk of electric shock, leakage-current or resistance measurements shall be carried out (exposed parts are acceptably insulated from the supply circuit) before the appliance is returned to the customer.

X09-A/8 -CN7

2/3

(A)

The DC voltage is an actual reading measured with a high impedance type voltmeter as the AM/FM signal generator is specified to the conditions as shown in the list below. The measurement value may vary depending on the measuring instruments used or on the product. The value shown in () is actual reading measured in the AM mode.

MODE	CARRIER	MODULATION		ANT INPUT
		FREQUENCY	DEVIATION	
FM	98MHz	1kHz	STEREO 67.5kHz 7.5kHz(Pilot)	60dB
AM	1000(999)kHz	400Hz	MONO 30% MOD	60dB

- AR-404(K,P) (1/3)
- KRF-A4020S(M,X,E) (1/3)
- KRF-A4030(E) (1/3)
- KRF-A4030E(E2) (1/3)

Y05-4040-10

AR-404/KRF-A4030/A4030E/A4030-S

KENWOOD

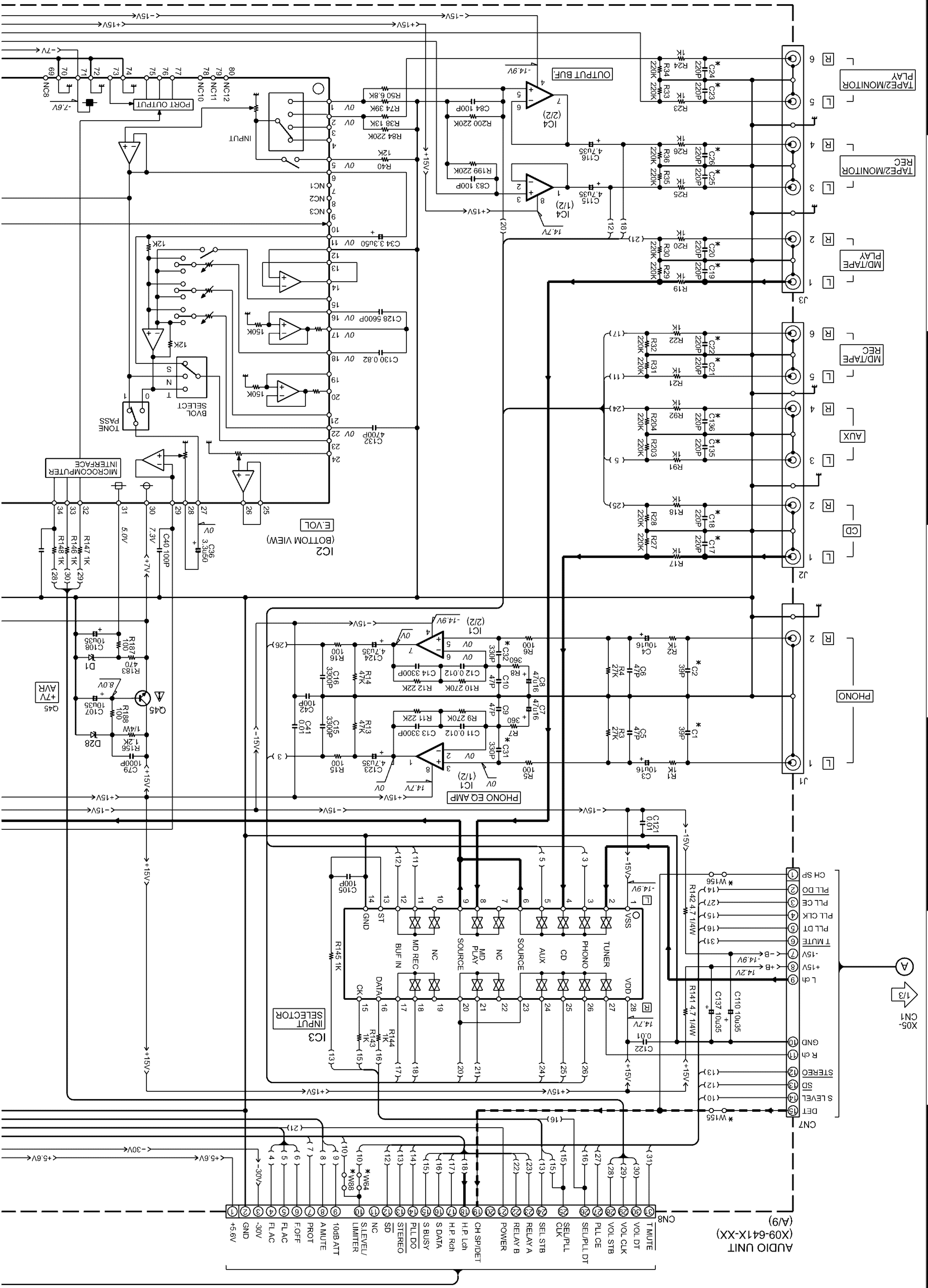



DESTINATION	ABB	1	2	3	4	5	6	7	8	9	10	11	12	13	14	15	16	17	18	19	20	21	22	23	24	25	26	27	28	29	30	31	32	33	34	35	36	37	38	39	40	41	42	43	44	45	46	47	48	49	50	51	52	53	54	55	56	57	58	59	60	61	62	63	64	65	66	67	68	69	70	71	72	73	74	75	76	77	78	79	80	81	82	83	84	85	86	87	88	89	90	91	92	93	94	95	96	97	98	99	100
AR-404 (M094410-10)	ABB	100K	200	300	400	500	600	700	800	900	1000	1100	1200	1300	1400	1500	1600	1700	1800	1900	2000	2100	2200	2300	2400	2500	2600	2700	2800	2900	3000	3100	3200	3300	3400	3500	3600	3700	3800	3900	4000	4100	4200	4300	4400	4500	4600	4700	4800	4900	5000	5100	5200	5300	5400	5500	5600	5700	5800	5900	6000	6100	6200	6300	6400	6500	6600	6700	6800	6900	7000	7100	7200	7300	7400	7500	7600	7700	7800	7900	8000	8100	8200	8300	8400	8500	8600	8700	8800	8900	9000	9100	9200	9300	9400	9500	9600	9700	9800	9900	10000
AR-404 (M094410-10)	ABB	100K	200	300	400	500	600	700	800	900	1000	1100	1200	1300	1400	1500	1600	1700	1800	1900	2000	2100	2200	2300	2400	2500	2600	2700	2800	2900	3000	3100	3200	3300	3400	3500	3600	3700	3800	3900	4000	4100	4200	4300	4400	4500	4600	4700	4800	4900	5000	5100	5200	5300	5400	5500	5600	5700	5800	5900	6000	6100	6200	6300	6400	6500	6600	6700	6800	6900	7000	7100	7200	7300	7400	7500	7600	7700	7800	7900	8000	8100	8200	8300	8400	8500	8600	8700	8800	8900	9000	9100	9200	9300	9400	9500	9600	9700	9800	9900	10000

CAUTION: For continued safety, replace safety critical components only with manufacturer's recommended parts (refer to parts list). Δ indicates safety critical components. For continued protection against risk of fire, replace only with same type and rating fuse(s). To reduce the risk of electric shock, leakage-current or resistance measurements shall be carried out (exposed parts are acceptably insulated from the supply circuit) before the appliance is returned to the customer.

The DC voltage is an actual reading measured with a high impedance type voltmeter with no signal input. The measurement value may vary depending on the measuring instruments used or on the product.

2SA1123 **2SC3940A** **DTC124ESA** **2SA1576A** **UN4212**
2SA992 **2SC1740S** **2SC1740S** **2SB1218A** **2SA1309A**
2SC2831 **2SC2631** **2SD1819A** **2SC3311A**
2SC4081 **TRAIT3N** **2SA6579R** **BR24C02**
2SD1757K **TRAIT3P** **SAAM579R** **NUM4580L-D**
DA204U **LC72131** **M62492FP** **NUM4565L-D**
AR-404(K,P) (2/3) **AR-404(S,M,X,E) (2/3)** **AR-403(E) (2/3)** **AR-403(E2) (2/3)**
Y05-4040-10
KENWOOD



AR-404 (X09-6410-10)

DESTINATION	ABB	UNIT No.	R503	R504	C503	C504	C505	C506	C507	W110.111	S505	S511	S512	D503	D504	D505	D506	D507	D510	IC51	
DESTINATION	ABB	UNIT No.	556	560	528	529	541	542	543	W110.111	555	561	562	D503	D504	D505	D506	D507	D510	IC51	
COUNTRY	X	0-10	NO	YES	NO	NO	NO	NO	NO	NO	NO	NO	NO	NO	NO	NO	NO	NO	NO	NO	NO
COUNTRY	F	0-10	NO	YES	NO	NO	NO	NO	NO	NO	NO	NO	NO	NO	NO	NO	NO	NO	NO	NO	NO

DESTINATION	ABB	UNIT No.	R503	R504	C503	C504	C505	C506	C507	W110.111	S505	S511	S512	D503	D504	D505	D506	D507	D510	IC51	
DESTINATION	ABB	UNIT No.	556	560	528	529	541	542	543	W110.111	555	561	562	D503	D504	D505	D506	D507	D510	IC51	
COUNTRY	X	0-71	NO	YES	NO	NO	NO	NO	NO	NO	NO	NO	NO	NO	NO	NO	NO	NO	NO	NO	NO
COUNTRY	E3	2-71	YES	NO	NO	NO	NO	NO	NO	NO	NO	NO	NO	NO	NO	NO	NO	NO	NO	NO	NO

CAUTION: For continued safety, replace safety critical components only with manufacturer's recommended parts (refer to parts list). Δ indicates safety critical components. For continued protection against risk of fire, replace only with same type and rating fuse(s). To reduce the risk of electric shock, leakage-current or resistance measurements shall be carried out (exposed parts are acceptably insulated from the supply circuit) before the appliance is returned to the customer.

The DC voltage is an actual reading measured with a high impedance type voltmeter with no signal input. The measurement value may vary depending on the measuring instruments used or on the product.

AR-404/KRF-A4030/A4030E/A4030-S
KENWOOD

EXPLODED VIEW (UNIT)

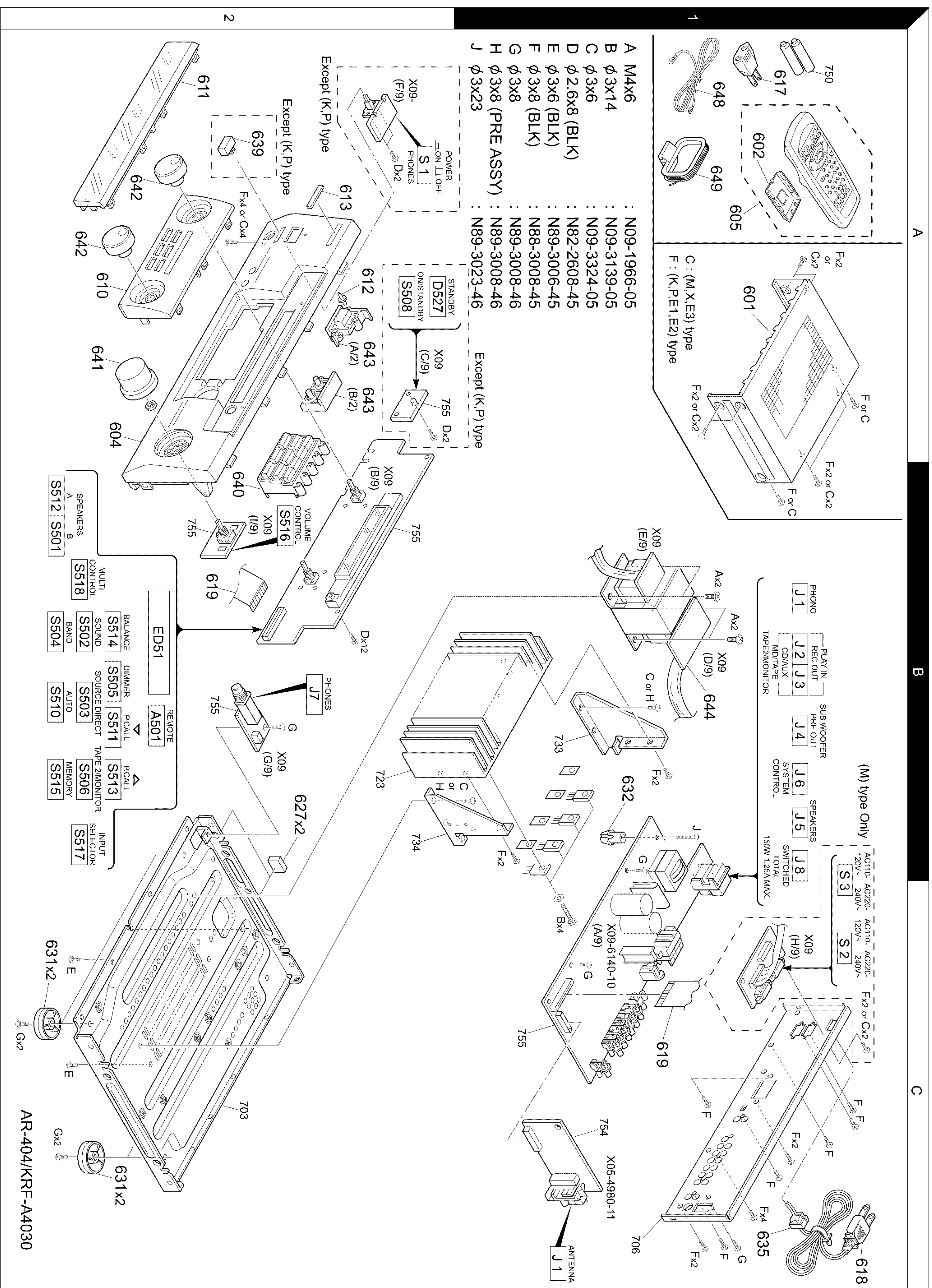

A

B

C

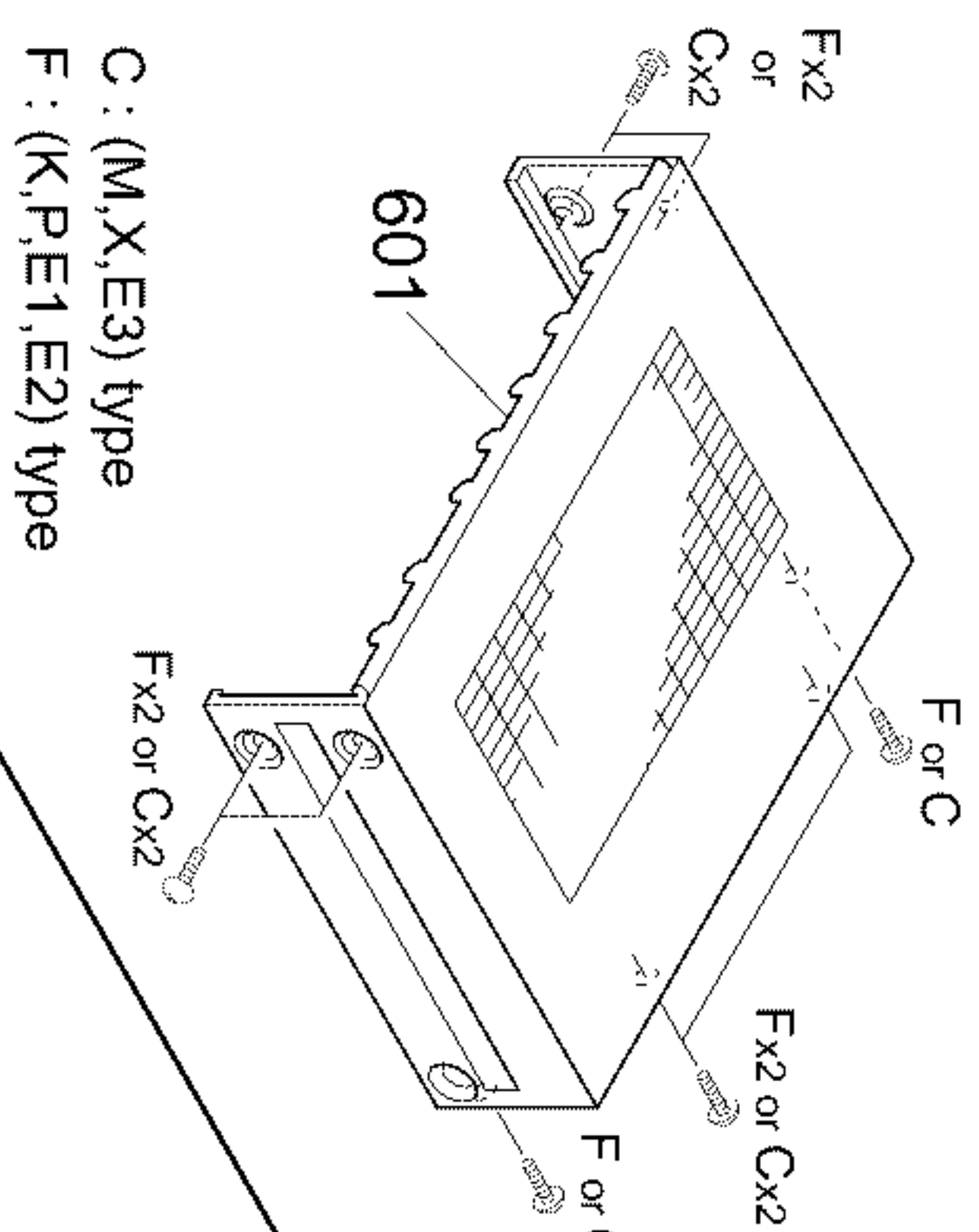
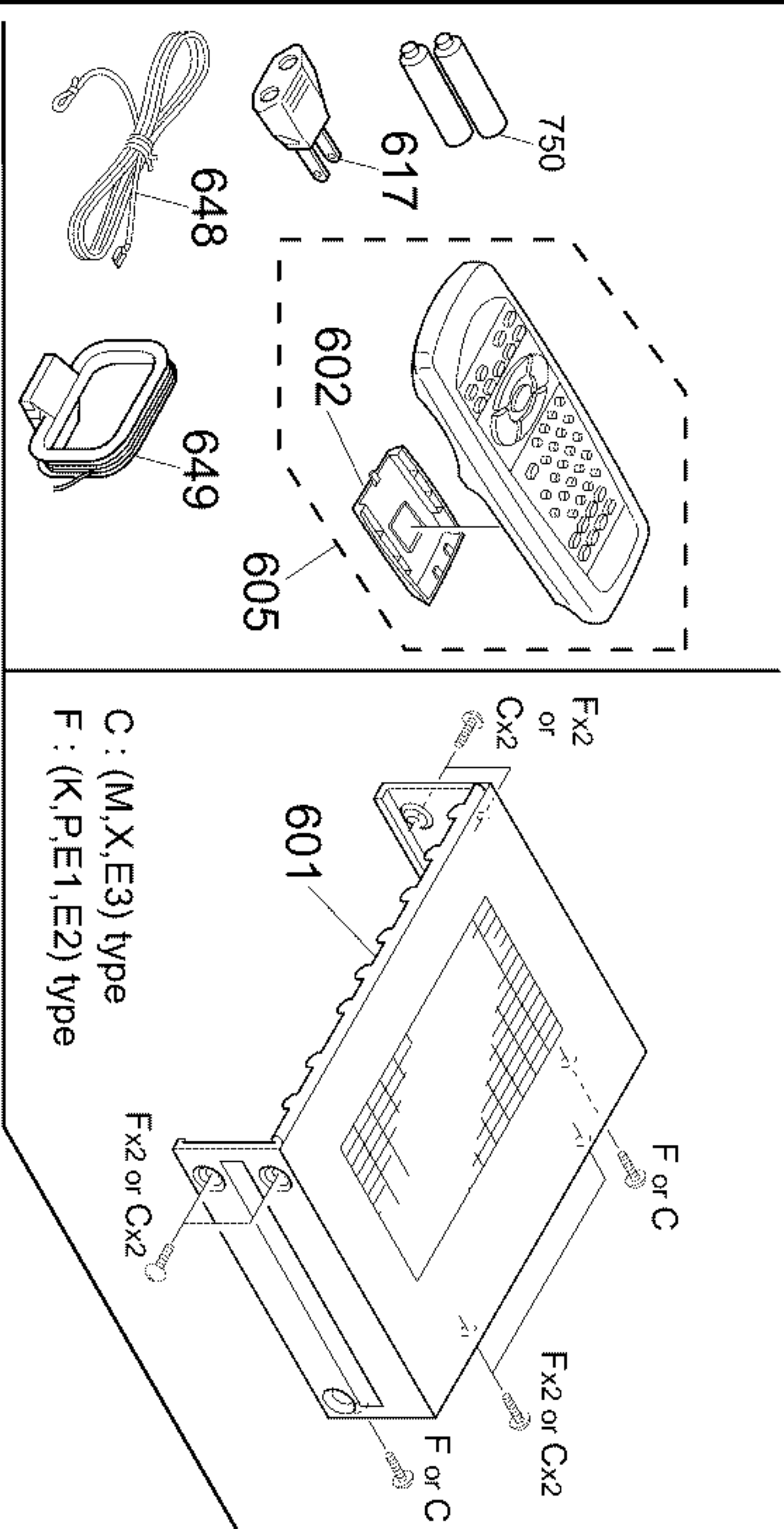

C : (M, X, E3) type
F : (K, P, E1, E2) type

- A M4X6 : N09-1966-05
- B ϕ 3X14 : N09-3139-05
- C ϕ 3X6 : N09-3324-05
- D ϕ 2.6X8 (BLK) : N82-2608-45
- E ϕ 3X6 (BLK) : N89-3006-45
- F ϕ 3X8 (BLK) : N88-3008-45
- G ϕ 3X8 : N89-3008-46
- H ϕ 3X8 (PRE ASSY) : N89-3008-46
- J ϕ 3X23 : N89-3023-46

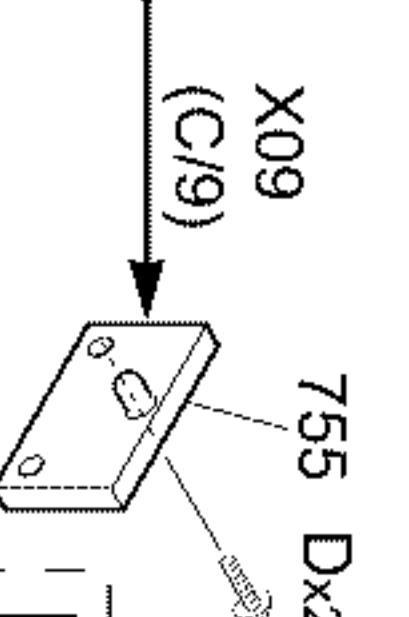

2

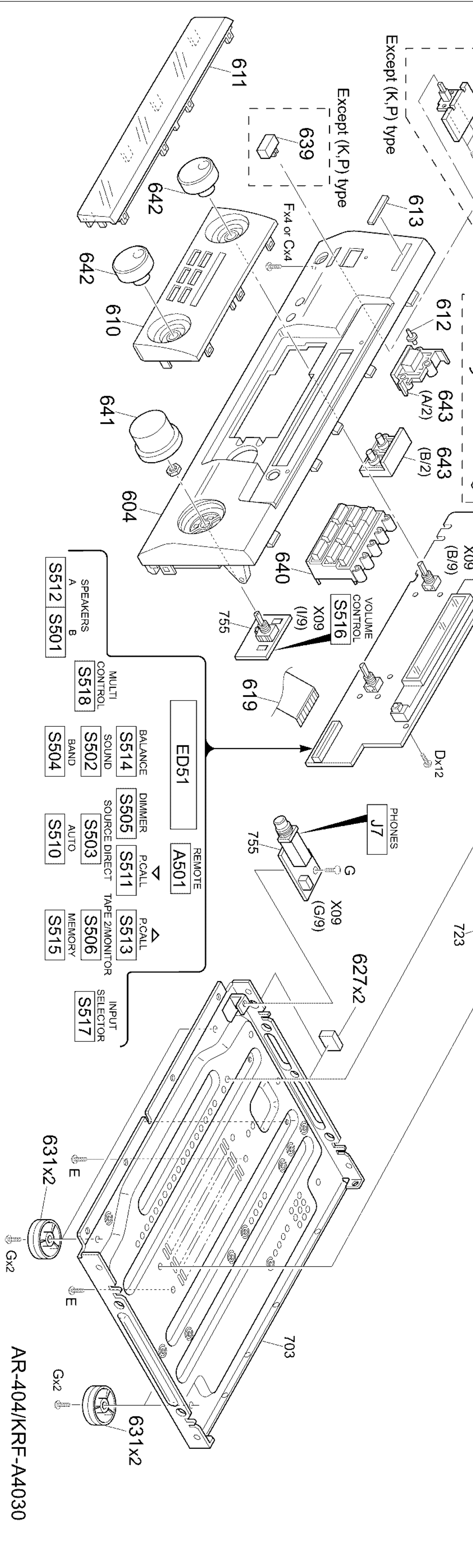

Parts with exploded numbers larger than 700 are not supplied.

* New Parts
Parts without **Parts No.** are not supplied.
Les articles non mentionnés dans le **Parts No.** ne sont pas fournis.
Telle ohne **Parts No.** werden nicht geliefert.



Ref. No	Add-ress	New Parts	Parts No.	Description	Desti-nation	Re-marks
AR-404/KRF-A4030/A4030E/A4030-S						
601	1A	*	A01-3733-01	METALLIC CABINET	E2	
601	1A	*	A01-3733-01	METALLIC CABINET	KPE1	
601	1A	*	A01-3734-01	METALLIC CABINET	MXE3	
602	1A	*	A09-1123-08	BATTERY COVER		
604	2A	*	A60-1762-01	PANEL	KP	
604	2A	*	A60-1763-01	PANEL	E1E2	
604	2A	*	A60-1764-01	PANEL	MXE3	
605	1A	*	A70-1266-05	REMOTE CONTROL ASSY(RC-R0709)	KPM	
605	1A	*	A70-1266-05	REMOTE CONTROL ASSY(RC-R0709)	X	
605	1A	*	A70-1267-05	REMOTE CONTROL ASSY(RC-R0708)	E1E2E3	
610	2A	*	B07-2479-02	ESCUTCHEON	KP	
610	2A	*	B07-2480-02	ESCUTCHEON	E3	
610	2A	*	B07-2504-02	ESCUTCHEON	MX	
610	2A	*	B07-2506-02	ESCUTCHEON	E1E2	
611	2A	*	B10-3576-02	FRONT GLASS	KP	
611	2A	*	B10-3577-02	FRONT GLASS	MX	
611	2A	*	B10-3578-12	FRONT GLASS	E1E2E3	
612	2A	*	B12-0385-04	INDICATOR		
613	2A	*	B43-0314-04	KENWOOD BADGE		
-	-	-	B46-0096-53	WARRANTY CARD	X	
-	-	-	B46-0310-03	WARRANTY CARD	E1E2E3	
-	-	-	B46-0328-03	WARRANTY CARD	K	
-	-	-	B46-0346-00	QUESTIONNAIRE CARD	K	
-	-	-	B46-0347-03	WARRANTY CARD	P	
-	-	-	B58-0964-13	CAUTION CARD (UL)	K	
-	-	-	B58-0965-13	CAUTION CARD (T,X)ypePL	X	
-	-	-	B58-0966-13	CAUTION CARD (ELM)ypePL	ME1E3	
-	-	-	B58-0967-03	CAUTION CARD (P)ypePL	P	
-	-	-	B58-1607-03	CAUTION CARD	E2	
-	-	-	B60-4556-00	INSTRUCTION MANUAL (EN)	KPM	
-	-	-	B60-4556-00	INSTRUCTION MANUAL (EN)	X	
-	-	-	B60-4557-00	INSTRUCTION MANUAL (EN)	E2	
-	-	-	B60-4558-00	INSTRUCTION MANUAL (FR)	P	
-	-	-	B60-4559-00	INSTRUCTION MANUAL (ENTC)	M	
-	-	-	B60-4560-00	INSTRUCTION MANUAL (FR/NE)	E1E3	
-	-	-	B60-4561-00	INSTRUCTION MANUAL (IT/ES)		
-	-	-	B60-4562-00	INSTRUCTION MANUAL (GE)	E1E3	
-	-	-	B60-4563-00	INSTRUCTION MANUAL (RU/PL)	E2	
-	-	-	B60-4564-00	INSTRUCTION MANUAL (HU/CZ)	E2	
-	-	-	E03-0115-05	AC PLUG ADAPTER	M	
-	-	-	E30-2717-05	AC POWER CORD	X	
-	-	-	E30-2941-05	AC POWER CORD	KP	
-	-	-	E30-2942-05	AC POWER CORD	E3	
-	-	-	E30-2942-05	AC POWER CORD	ME1E2	
619	1C,2B	*	E35-1772-05	FLAT CABLE		
627	2B	*	G11-2416-04	CUSHION		
-	-	-	H10-7628-02	POLYSTYRENE FOAMED FIXTURE		
-	-	-	H10-7629-02	POLYSTYRENE FOAMED FIXTURE		
-	-	-	H25-0232-04	PROTECTION BAG (235X350X0.03)		
-	-	-	H25-0391-04	PROTECTION BAG		
-	-	-	H50-3616-04	ITEM CARTON CASE	KP	

L: Scandinavia K: USA P: Canada R: Mexico C: China I: Malaysia
 Y: PX(Far East,Hawaii) T: England E: Europe G: Germany V: China(Shanghai)
 V: AAF(Europe) X: Australia Q: Russia H: Korea M: Other Areas Δ indicates safety critical components.

* New Parts
Parts without **Parts No.** are not supplied.
Les articles non mentionnés dans le **Parts No.** ne sont pas fournis.
Telle ohne **Parts No.** werden nicht geliefert.



Ref. No	Add-ress	New Parts	Parts No.	Description	Desti-nation	Re-marks
-	-	*	H50-3617-04	ITEM CARTON CASE	E1	
-	-	*	H50-3618-04	ITEM CARTON CASE	M	
-	-	*	H50-3619-04	ITEM CARTON CASE	XE3	
-	-	*	H50-3650-04	ITEM CARTON CASE	E2	
631	2C	*	J02-1464-03	FOOT		
632	1B	*	J19-3752-14	UNIT HOLDER		
635	1C	*	J42-0083-05	POWER CORD BUSHING		
-	-	-	J61-0307-05	WIRE BAND		
639	2A	*	K27-2384-04	KNOB (BUTTON)	E1E2	
639	2A	*	K27-2385-04	KNOB (BUTTON)	MXE3	
640	2B	*	K29-7675-12	KNOB	E2	
640	2B	*	K29-7675-12	KNOB	KPE1	
640	2B	*	K29-7676-12	KNOB	MXE3	
641	2A	*	K29-7678-04	KNOB (VOLUME)	E2	
641	2A	*	K29-7678-04	KNOB (VOLUME)	KPE1	
641	2A	*	K29-7679-04	KNOB (VOLUME)	MXE3	
642	2A	*	K29-7681-14	KNOB (MULTI/INPUT)	E2	
642	2A	*	K29-7681-14	KNOB (MULTI/INPUT)	KPE1	
642	2A	*	K29-7682-14	KNOB (MULTI/INPUT)	MXE3	
643	2A	*	K29-7687-03	KNOB (SPEAKER/POWER)	E2	
643	2A	*	K29-7687-03	KNOB (SPEAKER/POWER)	KPE1	
643	2A	*	K29-7688-03	KNOB (SPEAKER/POWER)	MXE3	
644	1B	*	L07-2638-05	POWER TRANSFORMER	E1E2E3	
644	1B	*	L07-2639-05	POWER TRANSFORMER	M	
644	1B	*	L07-2691-05	POWER TRANSFORMER	X	
644	1B	*	L07-2801-05	POWER TRANSFORMER	KP	
648	1A	*	T90-0836-05	LEAD WIRE ANTENNA		
649	1A	*	T90-0852-05	LOOP ANTENNA		
TUNER UNIT (X05-498X-XX)						
C1			CK73FB1H223K	CHIP C	K	
C2			CK73FB1H103K	CHIP C	K	
C3			CK73FB1H103K	CHIP C	K	
C5	6		CK73FB1H103K	CHIP C	K	
C7			CE04LW1C470M	ELECTRO	16WV	
C8			CK73EB1H103K	CHIP C	K	
C10			CE04LW1C470M	ELECTRO	16WV	
C11	12		CK73FB1H473K	CHIP C	K	
C14			CE04LW1C100M	ELECTRO	16WV	
C15			CE04LW1H010M	ELECTRO	50WV	
C16			C90-3251-05	ELECTRO	0.47UF	
C17			CE04LW1H010M	ELECTRO	47UF	
C18			CG73FC1H470J	CHIP C	10UF	
C19			C90-3217-05	ELECTRO	10UF	
C20			CK73FB1H473K	CHIP C	0.047UF	
C21			C90-3241-05	ELECTRO	3.3UF	
C22			CK73FB1H473K	CHIP C	0.047UF	
C23			CE04LW1C100M	ELECTRO	10UF	
C24			CK73FB1H331K	CHIP C	330PF	
C25			CC73FC1H181J	CHIP C	180PF	
C26			CC73FC1H471J	CHIP C	470PF	
C26			CK73FB1H183K	CHIP C	0.018UF	
C26			CK73FB1H223K	CHIP C	0.022UF	
C27			CE04HW1EARTM	NP-ELEC	4.7UF	
C28	29		CE04LW1H2R2M	ELECTRO	2.2UF	

L: Scandinavia K: USA P: Canada R: Mexico C: China I: Malaysia
 Y: PX(Far East,Hawaii) T: England E: Europe G: Germany V: China(Shanghai)
 V: AAF(Europe) X: Australia Q: Russia H: Korea M: Other Areas Δ indicates safety critical components.

PARTS LIST

AR-404/KRF-A4030/A4030E/A4030-S

* New Parts
Parts without **Parts No.** are not supplied.
Les articles non mentionnés dans le **Parts No.** ne sont pas fournis.
Telle ohne **Parts No.** werden nicht geliefert.

Ref. No	Add-ress	New Parts	Parts No.	Description	Desti-nation	Re-marks
C30 ,31			CK73FB1H223K	CHIP C	K	E2E3
C30 ,31			CK73FB1H223K	CHIP C	K	MXE1
C30 ,31			CK73FB1H333K	CHIP C	K	KP
C32			CE04LW1V4R7M	ELECTRO	35WV	
C33 ,34			CK73FB1H103K	CHIP C	K	M
C35			CK73FB1H332K	CHIP C	K	KPM
C35			CK73FB1H332K	CHIP C	K	X
C36			CK73FB1H103K	CHIP C	K	
C37 ,38			CE04LW1C100M	ELECTRO	16WV	
C39			CC73FCH1H060D	CHIP C	D	
C40			CC73FCH1H020C	CHIP C	C	
C41			CC73FCH1H220J	CHIP C	J	
C42			CC73FCH1H120J	CHIP C	J	
C43			CC73FCH1H100D	CHIP C	D	
C44			CK73FB1H471K	CHIP C	K	
C45			CC73FCH1H220J	CHIP C	J	
C46			CE04LW1C100M	ELECTRO	16WV	
C47			CK73FB1H102K	CHIP C	K	
C48			CE04LW1C470M	ELECTRO	16WV	
C49			CE04LW1H2R2M	ELECTRO	50WV	
C50			CC73FSL1H101J	CHIP C	J	
C51			CK73FB1H471K	CHIP C	K	
C52			CC73FSL1H101J	CHIP C	J	
C70 ,71			CK73FB1H822K	CHIP C	K	E1E2E3
C72			CE04LW1H010M	ELECTRO	50WV	
C73			CE04LW1C470M	ELECTRO	16WV	
C74			CK73FB1H102K	CHIP C	K	KP
C75			CC73FCH1H030C	CHIP C	C	
C76			CC73FCH1H470J	CHIP C	J	
C77			CC73FSL1H101J	CHIP C	J	M
C78			CK73FB1H223K	CHIP C	K	
C79 ,80			CK73FB1H472K	CHIP C	K	E1E2E3
C81			CK73FF1C105Z	CHIP C	Z	
C82			CK73FB1H103K	CHIP C	K	E2E3
C82			CK73FB1H103K	CHIP C	K	KPE1
C83			CC73FSL1H101J	CHIP C	J	
C84 ,85			CK73FB1H223K	CHIP C	K	
C86			CK73FB1H471K	CHIP C	K	
C88			CK73FB1H332K	CHIP C	K	
C89 ,90			CK73FB1H472K	CHIP C	K	KPMX
C91			CK73FF1C105Z	CHIP C	Z	
CN1			E40-9831-05	SOCKET FOR PIN ASSY		
CN2			E40-4871-05	PIN ASSY		E2E3
CN2			E40-4871-05	PIN ASSY		KPE1
J1			E20-0321-05	LOCK TERMINAL BOARD		
J1			E70-0052-05	LOCK TERMINAL BOARD		
E1			F10-1128-14	SHIELDING PLATE		E1E2E3
E1			F10-1129-14	SHIELDING PLATE		KPM
E1			F10-1129-14	SHIELDING PLATE		X
CF1 ,2			L72-0531-05	CERAMIC FILTER		MX
CF1 ,2			L72-0536-05	CERAMIC FILTER		E1E2E3
CF1 ,2			L72-0596-05	CERAMIC FILTER		KP
CF3			L72-0607-05	CERAMIC FILTER		MX
L1			L39-1384-05	COMBINATION COIL		

L: Scandinavia K: USA P: Canada R: Mexico C: China I: Malaysia
Y: PX(Far East,Hawaii) T: England E: Europe G: Germany V: China(Shanghai)
Y: AA(FES(Europe)) X: Australia Q: Russia H: Korea M: Other Areas Δ indicates safety critical components.

3

* New Parts
Parts without **Parts No.** are not supplied.
Les articles non mentionnés dans le **Parts No.** ne sont pas fournis.
Telle ohne **Parts No.** werden nicht geliefert.

Ref. No	Add-ress	New Parts	Parts No.	Description	Desti-nation	Re-marks
L2			L40-1091-17	SMALL FIXED INDUCTOR(1UH)		
L3			L30-0911-05	AM IFT		E2E3
L4			L30-0950-05	FM IFT		KPE1
L4			L30-0950-05	FM IFT		E2E3
L5			L30-0951-05	FM IFT		
L5			L30-0951-05	FM IFT		
L6 ,7			L79-1239-05	LC FILTER		KPE1
L9			L40-1001-17	SMALL FIXED INDUCTOR(10UH,K)		E1E2E3
X1			L77-2232-05	CRYSTAL RESONATOR		
R1			RK73FB2A101J	CHIP R	J	1/10W
R4			RK73FB2A681J	CHIP R	J	1/10W
R5			RK73FB2A332J	CHIP R	J	1/10W
R6			RK73FB2A221J	CHIP R	J	1/10W
R7			RK73FB2A821J	CHIP R	J	1/10W
R8			RK73FB2A100J	CHIP R	J	1/10W
R8			RK73FB2A330J	CHIP R	J	1/10W
R9			RK73FB2A391J	CHIP R	J	1/10W
R10			RK73FB2A102J	CHIP R	J	1/10W
R11			RK73FB2A220J	CHIP R	J	1/10W
R11			RK73FB2A330J	CHIP R	J	1/10W
R12			RK73FB2A101J	CHIP R	J	1/10W
R14			RK73FB2A101J	CHIP R	J	1/10W
R14			RK73FB2A101J	CHIP R	J	1/10W
R14			RK73FB2A271J	CHIP R	J	1/10W
R15			RK73FB2A333J	CHIP R	J	1/10W
R15			RK73FB2A333J	CHIP R	J	1/10W
R16			RK73FB2A220J	CHIP R	J	1/10W
R17			RK73FB2A362J	CHIP R	J	1/10W
R18			RK73FB2A302J	CHIP R	J	1/10W
R19			RK73FB2A822J	CHIP R	J	1/10W
R20			RK73FB2A392J	CHIP R	J	1/10W
R23			RK73FB2A153J	CHIP R	J	1/10W
R23			RK73FB2A332J	CHIP R	J	1/10W
R23			RK73FB2A472J	CHIP R	J	1/10W
R25			RK73FB2A183J	CHIP R	J	1/10W
R25			RK73FB2A223J	CHIP R	J	1/10W
R25			RK73FB2A273J	CHIP R	J	1/10W
R27 ,28			RK73FB2A432J	CHIP R	J	1/10W
R27 ,28			RK73FB2A622J	CHIP R	J	1/10W
R27 ,28			RK73FB2A752J	CHIP R	J	1/10W
R29			RK73FB2A101J	CHIP R	J	1/10W
R30			RK73FB2A561J	CHIP R	J	1/10W
R31			RK73FB2A473J	CHIP R	J	1/10W
R32			RK73FB2A272J	CHIP R	J	1/10W
R32			RK73FB2A272J	CHIP R	J	1/10W
R33 ,34			RK73FB2A102J	CHIP R	J	1/10W
R35			RK73FB2A101J	CHIP R	J	1/10W
R36			RK73FB2A102J	CHIP R	J	1/10W
R37			RK73FB2A392J	CHIP R	J	1/10W
R38			RK73FB2A102J	CHIP R	J	1/10W
R39			RK73FB2A103J	CHIP R	J	1/10W
R42			RK73FB2A103J	CHIP R	J	1/10W
R43			RK73FB2A221J	CHIP R	J	1/10W
R44			RD14NB2E271J	CHIP R	J	1/4W

L: Scandinavia K: USA P: Canada R: Mexico C: China I: Malaysia
Y: PX(Far East,Hawaii) T: England E: Europe G: Germany V: China(Shanghai)
Y: AA(FES(Europe)) X: Australia Q: Russia H: Korea M: Other Areas Δ indicates safety critical components.

4

PARTS LIST

AR-404/KRF-A4030/A4030E/A4030-S

PARTS LIST

Ref. No	Add-ress	New Parts	Parts No.	Description	Desti-nation	Re-marks
D8			MA1111	DIODE		
D9			HZS3.3N(B2)	ZENER DIODE		
D11			MTZJ3.3(B)	ZENER DIODE		
D13			MA1111	DIODE		
IC1			LA1837	ANALOGUE IC		E2E3
IC1			LA1837	ANALOGUE IC		KPE1
IC1			LA1838	ANALOGUE IC		MX
IC2			LC72131	MOS-IC		
Q1			2SC4081(R,S)	TRANSISTOR		
Q1			2SD1819A(Q,R)	TRANSISTOR		
Q2			2SA1576A(R,S)	TRANSISTOR		
Q2			2SB1218A(Q,R)	TRANSISTOR		
Q3			2SC4081(R,S)	TRANSISTOR		M
Q3			2SD1819A(Q,R)	TRANSISTOR		M
Q6			2SC4081(R,S)	TRANSISTOR		
Q6			2SD1819A(Q,R)	TRANSISTOR		
Q7			2SD1757K	TRANSISTOR		
Q10			2SA1576A(R,S)	TRANSISTOR		
Q12			2SB1218A(Q,R)	TRANSISTOR		
Q12			2SA1576A(R,S)	TRANSISTOR		
Q14			2SA1576A(R,S)	TRANSISTOR		
Q14			2SB1218A(Q,R)	TRANSISTOR		
A1			W02-2584-05	FM FRONT-END ASSY		E1E2E3
A1			W02-2622-05	FM FRONT-END ASSY		KPM
A1			W02-2622-05	FM FRONT-END ASSY		X
AUDIO UNIT (X09-641X-XX)						
D527			B30-2513-05	LED(RED)		
C1			CC45FSL1H390J	CERAMIC		E1E2E3
C3			CE04LW1C100M	ELECTRO		
C5			CC45FSL1H470J	CERAMIC		
C7			CE04LW1C470M	ELECTRO		
C9			CC45FSL1H470J	CERAMIC		
C11			CG93FMG1H123J	MYLAR		
C13			CG93FMG1H332J	MYLAR		
C17			CC45FSL1H221J	CERAMIC		E1E2E3
C27			CE04KW1H2R2M	ELECTRO		KPM
C27			CE04KW1H2R2M	ELECTRO		X
C27			CE04KW1H2R2M	ELECTRO		
C27			CE04KW1V4R7M	ELECTRO		
C29			CK45FF1H103Z	CERAMIC		E1E2E3
C30			CC45FSL1H101J	CERAMIC		Z
C30			CC45FSL1H101J	CERAMIC		J
C30			CC45FSL1H101J	CERAMIC		J
C30			CG93FMG1H103J	MYLAR		J
C31			CC45FSL1H331J	CERAMIC		E1E2E3
C33			CE04LW1H3R3M	ELECTRO		
C33			CE04LW1C220M	ELECTRO		50WV
C37			CE04LW1C220M	ELECTRO		16WV
C37			CE04LW1V4R7M	ELECTRO		35WV
C37			CE04LW1V4R7M	ELECTRO		35WV
C39			CC45FSL1H101J	CERAMIC		
C41			CK45FF1H103Z	CERAMIC		
C42			CC45FSL1H101J	CERAMIC		
C43			CE04KW1H2R2M	ELECTRO		
C45			CK45FBIH681K	CERAMIC		
C47			CK45FF1H103Z	CERAMIC		
C47			CK45FF1H103Z	CERAMIC		

* New Parts
Parts without **Parts No.** are not supplied.
Les articles non mentionnés dans le **Parts No.** ne sont pas fournis.
Teile ohne **Parts No.** werden nicht geliefert.



L : Scandinavia K : USA P : Canada R : Mexico C : China I : Malaysia
 V : PX(Far East,Hawaii) T : England E : Europe G : Germany V : China(Shanghai)
 Y : AAFES(Europe) X : Australia Q : Russia H : Korea M : Other Areas
 Δ indicates safety critical components.

Ref. No	Add-ress	New Parts	Parts No.	Description	Desti-nation	Re-marks
R45			RK73EB2B102J	CHIP R		
R46			RK73FB2A102J	CHIP R		
R47			RK73EB2B102J	CHIP R		
R48			RK73FB2A102J	CHIP R		
R49			RK73FB2A103J	CHIP R		
R50			RD14NB2E471J	RD		
R51			RK73FB2A562J	CHIP R		
R52			RK73FB2A101J	CHIP R		
R53			RK73FB2A222J	CHIP R		
R54			RK73FB2A102J	CHIP R		
R55			RK73FB2A333J	CHIP R		
R56			RK73FB2A102J	CHIP R		
R58			RK73FB2A123J	CHIP R		
R59			RK73FB2A122J	CHIP R		
R72			RK73FB2A153J	CHIP R		
R72			RK73FB2A392J	CHIP R		
R72			RK73FB2A822J	CHIP R		
R74			RK73FB2A473J	CHIP R		
R75			RK73FB2A822J	CHIP R		
R76			RK73FB2A182J	CHIP R		
R78			RK73FB2A821J	CHIP R		
R79			RK73FB2A332J	CHIP R		
R80			RK73FB2A223J	CHIP R		
R81			RS14KB3A151J	FL-PROOF RS		
R82			RK73FB2A272J	CHIP R		
R82			RK73FB2A272J	CHIP R		
R83			RK73FB2A102J	CHIP R		
R84			RK73EB2B102J	CHIP R		
R85			RK73FB2A105J	CHIP R		
R88			RK73FB2A563J	CHIP R		
R89			RK73FB2A333J	CHIP R		
VR1			R32-0037-05	SEMI FIXED VARIABLE RESISTOR		
W51			R92-0670-05	CHIP R		
W54			R92-0670-05	CHIP R		
W54			R92-0670-05	CHIP R		
W54			R92-0670-05	CHIP R		
W54			R92-0670-05	CHIP R		
W54			R92-0670-05	CHIP R		
W59			R92-0670-05	CHIP R		
W59			R92-0670-05	CHIP R		
W59			R92-0670-05	CHIP R		
W59			R92-0670-05	CHIP R		
W62			R92-0670-05	CHIP R		
W80			R92-0679-05	CHIP R		
W82			R92-0679-05	CHIP R		
W82			R92-0679-05	CHIP R		
W84			R92-0679-05	CHIP R		
W84			R92-0679-05	CHIP R		
D1			DA204U	DIODE		
D1			MA143A	DIODE		
D1			1SS302	DIODE		
D3			HZS8.2N(B2)	ZENER DIODE		
D3			MTZJ8.2(B)	ZENER DIODE		
D4			HZS5.1N(B2)	ZENER DIODE		
D4			MTZJ5.1(B)	ZENER DIODE		
D5			HZS2.7N(B2)	ZENER DIODE		
D5			MTZJ2.7(B)	ZENER DIODE		

* New Parts
Parts without **Parts No.** are not supplied.
Les articles non mentionnés dans le **Parts No.** ne sont pas fournis.
Teile ohne **Parts No.** werden nicht geliefert.



L : Scandinavia K : USA P : Canada R : Mexico C : China I : Malaysia
 V : PX(Far East,Hawaii) T : England E : Europe G : Germany V : China(Shanghai)
 Y : AAFES(Europe) X : Australia Q : Russia H : Korea M : Other Areas
 Δ indicates safety critical components.

* New Parts
Parts without **Parts No.** are not supplied.
Les articles non mentionnés dans le **Parts No.** ne sont pas fournis.
Teil ohne **Parts No.** werden nicht geliefert.

Ref. No	Add- ress	New Parts	Parts No.	Description	Desti- nation	Re- marks
C49 ,50			CC45FSL1H101J	CERAMIC		
C51 ,52			CE04KW1A101M	ELECTRO	J	
C53 ,54			CC45FSL1H020C	CERAMIC	10WV	
C55 ,58			CC45FSL1H101J	CERAMIC	C	
C59 ,60			CC45FSL2H470J	CERAMIC	J	
C61 ,62			CC45FSL1H101J	CERAMIC	J	
C63 ,64			CE04LW1H010M	ELECTRO	50WV	
C65 ,66			CQ93FMG1H104J	MYLAR	J	
C67 ,68			CQ93FMG1H224J	MYLAR	J	E2E3
C67 ,68			CQ93FMG1H224J	MYLAR	J	MXE1
C69 ,70			CK45FF1H103Z	CERAMIC	Z	
C71 ,74			CK45FF1H472Z	CERAMIC	Z	E1E2E3
C75			CK45FB1H102K	CERAMIC	K	
C76 ,77			CC45FSL1H221J	CERAMIC	J	
C78			CE04LW1C101M	ELECTRO	16WV	
C79			CK45FB1H102K	CERAMIC	K	
C80			CE04LW1V100M	ELECTRO	35WV	
C81			CE04LW1V331M	ELECTRO	35WV	
C82			CE04LW1V470M	ELECTRO	35WV	
C83 ,84			CC45FSL1H101J	CERAMIC	J	
C85 ,86			CE04LW1V100M	ELECTRO	10UF	
C87			CE04LW2A100M	ELECTRO	10UF	
C88			CE04LW2A470M	ELECTRO	47UF	
C89 ,90			CE04LW1E101M	ELECTRO	100UF	
C91			CE04LW1C101M	ELECTRO	100UF	
C92			CE04LW1V470M	ELECTRO	47UF	
C93			CE04LW1V102M	ELECTRO	1000UF	
C94			CE04LW1V470M	ELECTRO	47UF	
C95			CE04LW1V471M	ELECTRO	470UF	
C96 ,97			C90-3832-05	ELECTRO	4700UF	KPM
C96 ,97			C90-3832-05	ELECTRO	4700UF	X
C98 ,99			CK45FF1H103Z	CERAMIC	63WV	E1E2E3
C100			CE04LW1V471M	ELECTRO	4,7UF	
C101			CE04LW1A221M	ELECTRO	220UF	
C102			CE04LW1C101M	ELECTRO	100UF	
C103			CE04LW1H010M	ELECTRO	1,0UF	
C104			CE04HW1E220M	NP-ELEC	22UF	
C105,106			CC45FSL1H101J	CERAMIC	100PF	
C107 ,108			CE04LW1V100M	ELECTRO	10UF	
C109			CK45FB1H102K	CERAMIC	1000PF	K
C110			CE04LW1V100M	ELECTRO	10UF	35WV
C111			C91-1480-05	MP	0,22UF	250WV
C112,113			CK45FF1H103Z	CERAMIC	0,010UF	Z
C114			CE04LW1A470M	ELECTRO	47UF	10WV
C115,116			CE04LW1V470M	ELECTRO	4,7UF	35WV
C117			CK45FB1H102K	CERAMIC	1000PF	K
C118			CE04LW1C220M	ELECTRO	22UF	16WV
C119			CK45FB1H102K	CERAMIC	1000PF	K
C120			CE04LW1V100M	ELECTRO	10UF	35WV
C121,122			CK45FF1H103Z	CERAMIC	0,010UF	Z
C123,124			CE04LW1V470M	ELECTRO	4,7UF	35WV
C125,126			CC45FSL2H101J	CERAMIC	100PF	J
C125,126			CC45FSL2H101J	CERAMIC	100PF	J
C127 ,128			CQ93FMG1H562J	MYLAR	5600PF	KPM
					X	

L : Scandinavia K : USA P : Canada R : Mexico C : China I : Malaysia
 V : PX(Far East,Hawaii) T : England E : Europe G : Germany V : China(Shanghai)
 Y : AA(FS)(Europe) X : Australia Q : Russia H : Korea M : Other Areas Δ indicates safety critical components.

* New Parts
Parts without **Parts No.** are not supplied.
Les articles non mentionnés dans le **Parts No.** ne sont pas fournis.
Teil ohne **Parts No.** werden nicht geliefert.

Ref. No	Add- ress	New Parts	Parts No.	Description	Desti- nation	Re- marks
C129 ,130			C91-1584-05	MF-C		
C131 ,132		*	CQ93FMG1H472J	MYLAR	J	
C133			CE04HW1HR47M	NP-ELEC	50WV	
C134			CK45FB1H102K	CERAMIC	K	
C135 ,136			CC45FSL1H221J	CERAMIC	J	E1E2E3
C137			CE04LW1V100M	ELECTRO	10UF	
C502			CK45FF1H103Z	CERAMIC	0,010UF	35WV
C503			CK45FB1H102K	CERAMIC	1000PF	K
C504 ,505			CK45FF1H103Z	CERAMIC	0,010UF	Z
C506			CK45FB1H102K	CERAMIC	1000PF	K
C507			CK45FF1H103Z	CERAMIC	0,010UF	Z
C508			CC45FSL1H101J	CERAMIC	100PF	J
C509		*	CC45FSL1H101J	CERAMIC	100PF	J
C510			CE04RW0J101M	ELECTRO	100UF	6,3WV
			CC45FSL1H331J	CERAMIC	330PF	J
C511-514			CK45FF1H103Z	CERAMIC	0,010UF	Z
C515			CK45FB1H561K	CERAMIC	560PF	K
C516			CE04LW1H2R2M	ELECTRO	2,2UF	50WV
C517			CE04LW1H010M	ELECTRO	1,0UF	50WV
C518-520			CK45FF1H103Z	CERAMIC	0,010UF	Z
C521			CC45FSL1H101J	CERAMIC	100PF	J
C522			CC45FSL1H221J	CERAMIC	220PF	J
C523			CK45FF1H103Z	CERAMIC	0,010UF	Z
C524			CE04LW1A101M	ELECTRO	100UF	10WV
C525			CE04LW1H010M	ELECTRO	1,0UF	50WV
C526			CE04LW1A101M	ELECTRO	100UF	10WV
C527			CC45FCH1H470J	CERAMIC	47PF	J
C528			CC45FCH1H180J	CERAMIC	18PF	J
C529			CC45FSL1H101J	CERAMIC	100PF	J
C531			C90-1827-05	ELECTRO	0,047F	5,5WV
C534			CC45FSL1H151J	CERAMIC	150PF	J
C529			CC45FSL1H470J	CERAMIC	47PF	J
C529			CC45FSL1H470J	CERAMIC	47PF	J
C529			CK45FF1H103Z	CERAMIC	0,010UF	Z
C534			C90-1827-05	ELECTRO	0,047F	5,5WV
C534			C90-1827-05	ELECTRO	0,047F	5,5WV
C534			CC45FSL1H101J	CERAMIC	100PF	J
C538 ,539			CE04RW1C100M	ELECTRO	10UF	16WV
C540			CE04LW1A471M	ELECTRO	470UF	10WV
C541			CC45FSL1H331J	CERAMIC	330PF	J
C542			CC45FSL1H331J	CERAMIC	330PF	J
C542			CC45FSL1H331J	CERAMIC	330PF	J
C542			CC45FSL1H331J	CERAMIC	330PF	J
C545			CC45FSL1H101J	CERAMIC	100PF	J
C549			CC45FSL1H271J	CERAMIC	270PF	J
CN1			E40-4245-05	PIN ASSY		
CN2			E40-4245-05	PIN ASSY		
CN2			E40-4245-05	PIN ASSY		
CN6			E40-4281-05	PIN ASSY		
CN7			E40-9848-05	PIN ASSY		
CN8 ,9			E40-8319-05	FLAT CABLE CONNECTOR		
CN10			E40-3247-05	PIN ASSY		
CN11 ,12			E40-4871-05	PIN ASSY		
CN21			E40-3261-05	PIN ASSY		
J1			E63-0068-15	PIN JACK		
J2 ,3			E63-0047-15	PIN JACK		

L : Scandinavia K : USA P : Canada R : Mexico C : China I : Malaysia
 V : PX(Far East,Hawaii) T : England E : Europe G : Germany V : China(Shanghai)
 Y : AA(FS)(Europe) X : Australia Q : Russia H : Korea M : Other Areas Δ indicates safety critical components.

AR-404/KRF-A4030/A4030E/A4030-S

PARTS LIST

Ref. No	Add-ress	New Parts	Parts No.	Description	Desti-nation	Re-marks
J4			E63-0116-05	PIN JACK		
J4			E63-0164-05	PIN JACK		
J5			E70-0047-05	LOCK TERMINAL BOARD		
J6			E11-0293-05	MINIATURE PHONE JACK(2P V)		
J7			E11-0127-05	PHONE JACK (3P)		
J8			E03-0148-05	AC OUTLET	KP	
J8			E03-0149-05	AC OUTLET	E3	
J8			E03-0149-05	AC OUTLET	ME1E2	
J8			E03-0325-05	AC OUTLET	X	
F1			F05-2525-05	FUSE (SEMKO)	E3M	
F1			F05-2525-05	FUSE (SEMKO)	XE1E2	
F1			F50-0076-05	FUSE(5X20)	KP	
F2			F05-2525-05	FUSE (SEMKO)	M	
F3			F05-2525-05	FUSE (SEMKO)	E1E2E3	
F4 ,5			F05-6313-05	FUSE (SEMKO)	E2E3	
F4 ,5			F05-6313-05	FUSE (SEMKO)	MXE1	
F4 ,5			F50-0066-05	FUSE(5X20)	KP	
-			J19-5928-13	HOLDER		
CN4 ,5			J13-0075-05	FUSE CLIP	M	
CN13-14			J13-0075-05	FUSE CLIP		
CN15,16			J13-0075-05	FUSE CLIP		
CN17,18			J13-0075-05	FUSE CLIP	E1E2E3	
CN19,20			J13-0075-05	FUSE CLIP		
E1			J11-0808-05	WIRE CLAMP		
L1 ,2			L39-0085-05	PHASE COMPENSATION COIL	E1E2E3	
L501			L40-1091-17	SMALL FIXED INDUCTOR(1UH)	E1E2E3	
L502			L40-1001-17	SMALL FIXED INDUCTOR(10UH,K)	E1E2E3	
T1			L07-2575-05	POWER TRANSFORMER	E3	
T1			L07-2874-05	POWER TRANSFORMER	KP	
T1			L07-2875-05	POWER TRANSFORMER	XE1E2	
T1			L07-2876-05	POWER TRANSFORMER	M	
X501			L78-0290-05	REGULATOR (8MHZ)	E1E2E3	
X502			L77-2002-05	CRYSTAL RESONATOR(4,332MHZ)		
R63 ,64			RD14NB2E221J	RD		
R67 ,68			RD14NB2E221J	RD		
R69 ,70			RD14NB2E121J	RD		
R75 ,76			RD14NB2E470J	RD		
R81 ,82			RD14NB2E470J	RD		
R89 ,90			RD14NB2E392J	RD		
R93 ,94			RD14NB2E392J	RD		
R99 ,100			RD14NB2E100J	RD		
R107 ,108			RS14KB3D391J	FL-PROOF RS		
R111			RD14NB2E222J	RD		
R114			R92-1844-05	CARBON	KP	
R117			RD14NB2E4R7J	RD		
R118 ,119			RD14NB2E101J	RD		
R120			RS14KB3D221J	FL-PROOF RS		
R141 ,142			RD14NB2E4R7J	RD		
R156			RD14NB2E122J	RD		
R168			RD14NB2E1R0J	RD		
R182			RD14NB2E122J	RD		
R207 ,208			RS14KB3D100J	FL-PROOF RS		
R209			RD14NB2E561J	RD		

* New Parts
Parts without **Parts No.** are not supplied.
Les articles non mentionnés dans le **Parts No.** ne sont pas fournis.
Teile ohne **Parts No.** werden nicht geliefert.



Ref. No	Add-ress	New Parts	Parts No.	Description	Desti-nation	Re-marks
R209			RD14NB2E561J	RD		
R575 ,576			RD14NB2E221J	RD		
R579			RD14NB2E101J	RD		
VR1 ,2			R32-0030-05	SEMI FIXED VARIABLE RESISTOR		
K1			S76-0089-05	MAGNETIC RELAY		
K2 ,3			S76-0045-15	MAGNETIC RELAY		
S1			S68-0107-05	PUSH SWITCH		
S1			S68-0107-05	PUSH SWITCH		
S2 ,3			S62-0001-05	SLIDE SWITCH		
S501-506			S70-0031-05	TACT SWITCH		
S508			S70-0031-05	TACT SWITCH		
S510-515			S70-0031-05	TACT SWITCH		
S516			T99-0602-05	ROTARY ENCODER		
S517 ,518		*	T99-0630-05	ROTARY ENCODER		
D1			HZS5 ,1N(B2)	ZENER DIODE		
D1			MTZJ5 ,1(B)	ZENER DIODE		
D2			HZS4 ,7N(B2)	ZENER DIODE		
D2			MTZJ4 ,7(B)	ZENER DIODE		
D3			HSS104A	DIODE		
D3			1SS133	DIODE		
D4			HZS8 ,2N(B2)	ZENER DIODE		
D4			MTZJ8 ,2(B)	ZENER DIODE		
D5 ,6			HSS104A	DIODE		
D5 ,6			1SS133	DIODE		
D7 ,8			1SS244	DIODE		
D9 -12			HSS104A	DIODE		
D9 -12			1SS133	DIODE		
D13			HZS6 ,2N(B2)	ZENER DIODE		
D13			MTZJ6 ,2(B)	ZENER DIODE		
D14			HZS2 ,7N(B2)	ZENER DIODE		
D14			MTZJ2 ,7(B)	ZENER DIODE		
D15 -17			HSS104A	DIODE		
D15 -17			1SS133	DIODE		
D18			HZS5 ,6N(B2)	ZENER DIODE		
D18			MTZJ5 ,6(B)	ZENER DIODE		
D19			S1ZB20(4101)	DIODE		
D20 ,21			HZS16N(B2)	ZENER DIODE		
D20 ,21			MTZJ16(B)	ZENER DIODE		
D22			D4SBL20UF03	DIODE		
D23			HZS5 ,6N(B2)	ZENER DIODE		
D23			MTZJ5 ,6(B)	ZENER DIODE		
D24 -27			S5688B	DIODE		
D24 -27			1SR139-400	DIODE		
D28			HZS8 ,2N(B2)	ZENER DIODE		
D28			MTZJ8 ,2(B)	ZENER DIODE		
D31 ,32			HSS104A	DIODE		
D31 ,32			1SS133	DIODE		
D33 ,34			HZS13N(B2)	ZENER DIODE		
D33 ,34			HZS15N(B2)	ZENER DIODE		
D33 ,34			MTZJ13(B)	ZENER DIODE		
D33 ,34			MTZJ15(B)	ZENER DIODE		
D35 ,36			HZS18N(B2)	ZENER DIODE		
D35 ,36			HZS20N(B2)	ZENER DIODE		
D35 ,36			MTZJ18(B)	ZENER DIODE		

* New Parts
Parts without **Parts No.** are not supplied.
Les articles non mentionnés dans le **Parts No.** ne sont pas fournis.
Teile ohne **Parts No.** werden nicht geliefert.



L : Scandinavia
V : PX(Far East,Hawaii)
Y : AAF(Europe)

L : Scandinavia
Y : PX(Far East,Hawaii)
Y : AAF(Europe)

SPECIFICATIONS

For U.S.A. and Canada

[AUDIO section]

Rated power output during STEREO operation

100 watts per channel minimum RMS, both channels driven, at 8 Ω from 40 Hz to 20 KHz with no more than 0.5 % total harmonic distortion. (FTC)

Total harmonic distortion 0.02 % (1 KHz, 50 W, 8 Ω)

Signal to noise ratio (IHF'66)

PHONO (MM) 75 dB

CD 92 dB

Input sensitivity / impedance

PHONO (MM) 2.5 mV / 27 KΩ

CD 200 mV / 47 KΩ

Output level / impedance

TAPE REC 200 mV / 2.2 KΩ

PRE OUT (SUBWOOFER) 2 V / 2.2 KΩ

Tone control

BASS ±9 dB (at 100 Hz)

TREBLE ±9 dB (at 10 KHz)

[FM tuner section]

Tuning frequency range 87.5 MHz ~ 108.0 MHz

Usable sensitivity (MONO) 1.6 μV (75 Ω) / 15.2 dBf

(75 KHz DEV., SINAD 30 dB)

50dB quieting sensitivity

STEREO 31.6 μV (75 Ω) / 41.2 dBf

Total harmonic distortion (1 KHz)

MONO 0.6 % (65 dBf input)

STEREO 0.7 % (65 dBf input)

Signal to noise ratio (1 KHz, 75 KHz DEV.)

MONO 75 dB (65 dBf input)

STEREO 68 dB (65 dBf input)

Stereo separation (1 KHz) 38 dB

Selectivity (±400 KHz) 65 dB

Frequency response (30 Hz ~ 15KHz), +0.5 dB ~ -3.0 dB

[AM tuner section]

Tuning frequency range 530 KHz ~ 1,700 KHz

Usable sensitivity (30% mod., S/N 20 dB)

Signal to noise ratio (30% mod. 1 mV input) 50 dB

[GENERAL]

Power consumption 2.8 A

AC outlet

SWITCHED 2 (total 150 W, 1.25 A max.)

Dimensions W:440 mm (17-5/16")

H:144 mm (5-11/16")

D:389 mm (15-5/16")

Weight (Net) 8.0 kg (17.6 lb)

For other countries

[AUDIO section]

Effective power output during STEREO operation

1KHz, 10% T.H.D., at 8 Ω 140 W + 140 W

100 watts per channel minimum RMS, both channels driven, at 8 Ω from 40 Hz to 20 KHz with no more than 0.5 % total harmonic distortion.(FTC)
--

Total harmonic distortion 0.02 % (1 KHz, 50W, 8 Ω)

Signal to noise ratio (IHF'66)

PHONO (MM) 75 dB

CD 92 dB

Input sensitivity / impedance

PHONO (MM) 2.5 mV / 27 KΩ

CD 200 mV / 47 KΩ

Output level / impedance

TAPE REC 200 mV / 2.2 KΩ

PRE OUT (SUBWOOFER) 2 V / 2.2 KΩ

Tone control

BASS ±9 dB (at 100 Hz)

TREBLE ±9 dB (at 10 KHz)

[FM tuner section]

Tuning frequency range 87.5 MHz ~ 108.0 MHz

Usable sensitivity (MONO) 1.6 μV (75 Ω) / 15.2 dBf

(75 KHz DEV., SINAD 30 dB)

50dB quieting sensitivity

STEREO 31.6 μV (75 Ω) / 41.2 dBf

Total harmonic distortion (1 KHz)

MONO 0.6 % (65 dBf input)

STEREO 0.7 % (65 dBf input)

Signal to noise ratio (1 KHz, 75 KHz DEV.)

MONO 75 dB (65 dBf input)

STEREO 68 dB (65 dBf input)

Stereo separation (1 KHz) 38 dB

Selectivity (±400 KHz) 65 dB

Frequency response (30 Hz~15KHz), +0.5 dB ~ -3.0 dB

[AM tuner section]

Tuning frequency range

9 KHz step 531 KHz ~ 1,602 KHz

10 KHz step (except Australia) ... 530 KHz ~ 1,610 KHz

Usable sensitivity (30% mod., S/N 20 dB)

Signal to noise ratio (30% mod. 1 mV input) 50 dB

[GENERAL]

Power consumption 280 W

AC outlet

SWITCHED (for Australia) 1 (total 150 W max.)

SWITCHED (except Australia) ... 2 (total 150 W max.)

Dimensions W:440 mm (17-5/16")

H:144 mm (5-11/16")

D:389 mm (15-5/16")

Weight (Net) 8.0 kg (17.6 lb)

Note:
Component and circuit are subject to modification to insure best operation under differing local conditions. This manual is based on Europe (E) standard, and provides information on regional circuit modification through use of alternate schematic diagrams, and information on regional component variations through use of parts list.

KENWOOD CORPORATION

14-6,Dogenzaka 1-chome, Shibuya-ku, Tokyo, 150-8501 Japan

KENWOOD SERVICE CORPORATION

P.O BOX 22745, 2201 East Dominguez St., Long Beach, CA 90801-5745, U.S.A.

KENWOOD ELECTRONICS CANADA INC.

6070 Keelel Road, Mississauga, Ontario, Canada L5T 1S8

KENWOOD ELECTRONICS LATIN AMERICA S.A.

P.O.BOX 55-2791, Piso 6 plaza Chase, Cl.47 y Aquilino de la Guardia, Panama, Republic de Panama

KENWOOD ELECTRONICS BRASIL LTDA.

Av. Moema, 170-17, Andar-Cobertura "B", Ed. Maximum Service Center, 04077-020 Moema, São Paulo-Sp-Brasil

KENWOOD ELECTRONICS U.K. LIMITED

KENWOOD House, Dwight Road, Watford, Herts, WD1 8EB, United Kingdom

KENWOOD ELECTRONICS BELGUM N.V.

Meachelsesteenweg 418, B-1930 Zaventem, Belgium

KENWOOD ELECTRONICS DEUTSCHLAND GMBH

Rembrandt-Str., 15, 63150 Heusenstamm, Germany

KENWOOD ELECTRONICS FRANCE S.A.

13 Boulevard Ney, 75018 Paris, France

KENWOOD ELECTRONICS ITALIA S.p.A.

Via G. Sironi, 7/9 20129, Milano, Italy

KENWOOD IBERICA S.A.

Bolivia, 239-08020 Barcelona, Spain

KENWOOD ELECTRONICS AUSTRALIA PTY. LTD.

(A.C.N. 001 499 074)

16 Giffnock Avenue, North Ryde, N.S.W. 2113, Australia

KENWOOD ELECTRONICS (HONG KONG) LTD.

Unit 3712-3724, Tower 1, Metroplaza, 223 Hing Fong Road, Kwai Fong N.T., Hong Kong

KENWOOD ELECTRONICS GULF FZE

P.O.Box 61318, Jebel Ali, Dubai, U.A.E.

KENWOOD ELECTRONICS SINGAPORE PTE LTD.

No. 1 Genting Lane #02-02, KENWOOD Building, Singapore, 349544

KENWOOD ELECTRONICS (MALAYSIA) SDN BHD.

#4.01 Level 4, Wisma Academy Lot 4A, Jalan 19/1 46300 Petaling Jaya Selangor Darul Ehsan Malaysia

KENWOOD ELECTRONICS (THAILAND) CO., LTD.

2019 New Pechburi Road, Bangkapi, Huaykwang, Bangkok, 10320 Thailand

Notes:

1. KENWOOD follows a policy of continuous advancements in development. For this reason specifications may be changed without notice.
2. The full performance may not be exhibited in an extremely cold location (under a water-freezing temperature).